



# BLADDERSCAN BVI 9600

## Operations & Maintenance Manual



BLADDERSCAN  
**BVI 9600**  
Operations & Maintenance Manual

Effective: November 2, 2015

Caution: Federal (United States) law restricts this device to sale by or on the order of a physician.

## CONTACT INFORMATION

To obtain additional information regarding your BladderScan system, please contact Verathon® Customer Care or visit [verathon.com/contact-us](http://verathon.com/contact-us).



### Verathon Inc.

20001 North Creek Parkway  
Bothell, WA 98011 U.S.A.  
800.331.2313 (US and Canada only)  
425.867.1348  
Fax: 425.883.2896  
[verathon.com](http://verathon.com)



### Verathon Medical (Europe) B.V.

Willem Fenengastraat 13  
1096 BL Amsterdam  
The Netherlands  
Tel: +31 (0) 20 210 30 91  
Fax: +31 (0) 20 210 30 92  
[verathon.com](http://verathon.com)

CE 0123

Copyright 2009, 2015 Verathon Inc. All rights reserved. No part of this manual may be copied or transmitted by any method without the express written consent of Verathon Inc.

Verathon, the Verathon torch symbol, AortaScan, BladderScan, the BladderScan symbol, ScanPoint, V<sub>MODE</sub>, and NeuralHarmonics are trademarks or registered trademarks, and Total Reliability Plan is a service mark of Verathon Inc. Bluetooth® word mark and logos are owned by the Bluetooth SIG, Inc. and any use of such marks by Verathon is under license. All other brand and product names are trademarks or registered trademarks of their respective owners.

Information in this manual may change at any time without notice. For the most up-to-date information, see the documentation available at [verathon.com](http://verathon.com).

# TABLE OF CONTENTS

---

- IMPORTANT INFORMATION..... 1**
- Overview ..... 1
- Product Description ..... 1
- Notice to All Users ..... 2
- Statement of Prescription ..... 2
- Statement of Intended Use ..... 2
- Essential Performance ..... 3
- Safety Information ..... 3
- Ultrasound Energy Safety ..... 3
- Contraindications ..... 3
- Cautions & Warnings ..... 4
- INTRODUCTION ..... 9**
- Components & Features ..... 9
- Probe Components ..... 10
- Console Components ..... 11
- Battery Charger/Wireless Hub Components ..... 12
- System Components & Accessories ..... 13
- Icons & Buttons ..... 14
- Console Display Icons ..... 14
- Variable Button Functions ..... 15
- Button Functions for Each Display Screen ..... 16
- Display Screens ..... 19
- Sleep Mode ..... 35
- Histogram of Cost Savings ..... 35

**SETTING UP .....36**

- Procedure 1. Perform the Initial Inspection .....36*
- Procedure 2. Set Up the Battery .....37*
- Procedure 3. Attach the Probe to the Console .....39*
- Procedure 4. Program the Clinic Name .....40*
- Procedure 5. Set the Date and Time .....42*
- Procedure 6. Load the Thermal Paper .....43*
- Procedure 7. Attach the Instrument to a Medical Cart (Optional) .....44*
- Procedure 8. Install ScanPoint with QuickPrint (Optional) .....46*
- Procedure 9. Watch the Training Video.....46*

**USING THE DEVICE .....47**

- Measuring Bladder Volume .....47
  - Procedure 1. Prepare for the Exam .....48*
  - Procedure 2. Measure Bladder Volume .....49*
  - Procedure 3. Save, Review, & Print Exam Results.....52*
  - Procedure 4. Delete a Saved Exam .....53*
- Measuring Abdominal Aortic Diameter .....54
  - Procedure 1. Prepare for the Exam .....57*
  - Procedure 2. Measure Abdominal Aortic Diameter .....58*
  - Procedure 3. Measure Aortic Diameter Manually (Optional) .....60*
  - Procedure 4. Interpret the Aortic Measurement Results .....61*
  - Procedure 5. Save, Review, & Print Exam Results.....65*
  - Procedure 6. Delete a Saved Exam .....66*

**CLEANING & MAINTENANCE .....67**

- Cleaning & Disinfecting .....67
  - Procedure 1. Clean the Instrument* .....67
  - Procedure 2. Disinfect the Instrument* .....68
- Regular Inspections .....69
- Maintenance .....69
  - Procedure 1. Run a Self Test* .....69
  - Procedure 2. Update the Software* .....70
  - Procedure 3. Calibrate the Probe Using the ScanPoint System* .....72
- Device Disposal .....75

**TROUBLESHOOTING .....76**

- Help Resources .....76
- Device Repair .....76
- Troubleshooting Procedures .....77
  - Procedure 1. Troubleshoot ScanPoint Connection* .....77
  - Procedure 2. Troubleshoot Power Issues* .....78
  - Procedure 3. Troubleshoot Overheating Instrument* .....78
  - Procedure 4. Clear a Paper Jam* .....78

**WARRANTY.....79**

**PRODUCT SPECIFICATIONS.....80**

- Component Specifications .....80
  - Console & Probe Specifications .....80
  - Battery Specifications.....82
  - Battery Charger/Wireless Hub Specifications .....83
- Bluetooth Wireless Technology.....83
- Electromagnetic Compatibility.....84
  - Electromagnetic Emissions .....84
  - Electromagnetic Immunity .....85
  - Recommended Separation Distances.....87
  - Accessory Conformance to Standards.....87

**SYMBOL DIRECTORY .....88**

**GLOSSARY .....91**



# IMPORTANT INFORMATION

## OVERVIEW

### PRODUCT DESCRIPTION

The BladderScan BVI 9600, with NeuralHarmonics® technology, is a portable ultrasound instrument that provides noninvasive measurements of urinary bladder volume or abdominal aortic diameter. The device consists of an ultrasound Probe that scans the patient’s bladder or aorta, and a compact, battery-operated console that provides measurement-related information.

The BladderScan BVI 9600 in AortaScan® mode can measure aortic diameters ranging between 3 and 12.4 cm with a diameter accuracy of  $\pm$  (15% + 0.5 cm). This error-range data (Table 1) indicates a range of values obtained by the device relative to follow up and clinical significance, specifically with respect to risk vs. diameter.

Table 1. Expected Aortic Measurement Ranges

ACTUAL AORTIC DIAMETER												
	3.0 cm		3.5 cm		4.0 cm		4.1 cm		5.0 cm		5.3 cm	
Average estimated risk of rupture for actual aortic diameter	0%		0%		0%		1%		11%		11%	
Aortic diameter as reported by the device based on allowable tolerances												
	Min	Max	Min	Max	Min	Max	Min	Max	Min	Max	Min	Max
$\pm$ 15%	2.55	3.45	2.98	4.03	3.40	4.60	3.49	4.72	4.25	5.75	4.51	6.10
With additional $\pm$ 0.5 cm	2.05	3.95	2.48	4.53	2.90	5.10	2.99	5.22	3.75	6.25	4.01	6.60
Average estimated risk of rupture for reported aortic diameter	0%	0%	0%	1%	0%	1%	0%	11%	0%	26%	0.5–5.0%	26%

Note: The BladderScan BVI 9600 is not intended to detect, identify, screen for, or diagnose abdominal aortic aneurysms (AAAs).

The BladderScan BVI 9600 is quick and easy to use. Within seconds of releasing the scan button, the BVI 9600 measures ultrasonic reflections on multiple planes inside the patient’s body and produces a three-dimensional image. Based on this image, the BVI 9600 calculates and displays the bladder volume or approximate abdominal aortic diameter. A sonographer is not required.

In the BVI 9600, NeuralHarmonics technology (abbreviated from “neural network harmonics”) sharpens accuracy and accelerates speed of bladder volume measurement. Volume measurements made with NeuralHarmonics technology are more accurate than those from conventional two-dimensional ultrasound, as they are based on a more complex, multifaceted image of the bladder. This technology, applying multi-spectral analysis to a robust data set, helps reduce margin of error and minimize uncertainty in essential measurements of bladder function. Using patented V<sub>MODE</sub><sup>®</sup> technology, the BladderScan BVI 9600 provides a noninvasive measurement of abdominal aortic diameter.

BladderScan BVI 9600 measurements can be printed via an onboard printer or transmitted using HIPAA-compliant ScanPoint<sup>®</sup> technology for storage and archiving on Verathon<sup>®</sup> servers. Stored exams can be accessed at any time from your office’s computer for viewing or printing.

*Note: Use of ScanPoint software is optional.*

If needed, after a scan has been taken, a unique aiming icon guides the operator to optimal Probe placement with a comprehensive, three-dimensional display showing the bladder in two cross-sectional images verifying that a complete scan has been achieved. Bladder volume, patient type, directional aiming with real-time feedback, battery status, and usage rate indicators are all displayed on the device’s LCD screen. The BladderScan BVI 9600 contains an on-board thermal printer that allows the user to print exam results quickly with the press of a button.

A calibration targeting system, consisting of a spiral-shaped calibration target along with a special calibration container, allows the user to easily calibrate the device by scanning a known target.

Optionally, exam results may be transmitted to a personal computer running ScanPoint with QuickPrint software via a proprietary wireless connection. ScanPoint with QuickPrint allows the user to archive data, calibrate the device, update software, print, and transfer data through a web-based interface.

The BladderScan BVI 9600 system also includes a universal battery charger for the custom, user-replaceable Lithium Ion battery incorporated in the system.

The BladderScan BVI 9600 may be mounted on a cart, which holds the instrument securely and provides a holder for ultrasound gel and other accessories.

## NOTICE TO ALL USERS

The BladderScan BVI 9600 should be used only by individuals who have been trained and authorized by a physician or the institution providing patient care. All users must read this entire User’s Manual prior to using the BladderScan BVI 9600. Do not attempt to operate this instrument until you thoroughly understand all instructions and procedures in this manual. Failure to comply with these instructions may compromise the performance of the device and the reliability of its measurements.

## STATEMENT OF PRESCRIPTION

Caution: Federal (United States) law restricts this device to sale by or on the order of a physician.

## STATEMENT OF INTENDED USE

The BladderScan BVI 9600 with AortaScan<sup>®</sup> Mode is a user-selectable, dual-function ultrasound device that projects ultrasound energy either into the lower abdomen to obtain an image of the bladder for measuring bladder volume, or into the mid-abdomen to obtain an image of the abdominal aorta for aortic diameter measurements.

## ESSENTIAL PERFORMANCE

*Essential performance* is the system performance necessary to achieve freedom from unacceptable risk. The essential performance of the BladderScan BVI 9600 system is to produce ultrasonic output energy, display ultrasonic images, and display numerical values for bladder volume and/or aortic diameter. The system has a temperature-controlled transducer assembly.

## SAFETY INFORMATION

### ULTRASOUND ENERGY SAFETY

To date, exposure to pulsed diagnostic ultrasound has not been shown to produce adverse effects. However, ultrasound should be used prudently, and total patient exposure should be kept *as low as reasonably achievable* (ALARA). Following the ALARA principle, ultrasound should only be used by medical professionals when clinically indicated, using the lowest possible exposure times necessary to obtain clinically useful information. For more information on ALARA, please refer to the American Institute of Ultrasound in Medicine publication, *Medical Ultrasound Safety*.

The ultrasound output power of the system is not user adjustable and is limited to the minimum level necessary for effective performance. For more information about acoustic output levels, see the [Product Specifications](#) chapter on page 80.

### CONTRAINDICATIONS

The BladderScan BVI 9600 is not intended for fetal use or for use on pregnant patients.

The BladderScan BVI 9600 is not intended for acute events such as aortic dissection, ulcer, or rupture.

## CAUTIONS & WARNINGS

*Warnings* indicate that injury, death, or other serious adverse reactions may result from use or misuse of the device. *Cautions* indicate that use or misuse of the device may cause a problem, such as a malfunction, failure, or damage to the product. Throughout the manual, pay attention to sections labeled *Important*, as these contain reminders or summaries of the following cautions as they apply to a specific component or use situation.

Please heed the following warnings and cautions.

### PRECAUTIONS



#### CAUTION

**Potential Device Interference.** Bluetooth® and wireless LAN devices operate within the same radio frequency range and may interfere with one another.

If you are using the BladderScan BVI 9600 Bluetooth link and wireless LAN devices simultaneously, you may experience less-than-optimal network performance or even lose your network connection. If this happens, you may need to move the BladderScan and ScanPoint® host computer to an area away from the 2.4 GHz wireless LAN devices (40 meters/44 yards, or more).



#### CAUTION

Use of the following cleaning methods or solutions may cause device damage not covered by the BladderScan BVI 9600 warranty.

- Do not immerse the instrument in disinfectant solution.
- Do not use Cidex Plus® to disinfect the instrument. Cidex Plus will damage the plastic enclosure.
- Do not subject any part of the instrument to steam sterilization or ethylene oxide sterilization.



#### CAUTION

When using the BladderScan BVI 9600 with optional ScanPoint® software, your computer must be minimally certified to EN / IEC / CSA / UL 60950 or 60101-1 standards. This configuration ensures that compliance to the EN/IEC 60601-1-1 system standard is maintained. Anyone connecting additional equipment to the BladderScan BVI 9600 signal input port or signal output port configures a medical system, and is therefore responsible for ensuring that the system complies with EN/IEC 60601-1-1. If you need assistance, contact your biomedical staff, Verathon® representative, or Verathon Customer Care.



#### CAUTION

The BladderScan BVI 9600 and related devices may contain mineral oils, batteries, and other environmentally hazardous materials. When the instrument and/or accessories have reached the end of their useful service life, see the section [Device Disposal](#) on page 75.



## CAUTION

Medical electrical equipment requires special precautions regarding electromagnetic compatibility (EMC) and must be installed and operated according to the instructions in this manual. For more information, see the [Electromagnetic Compatibility](#) section on page 84.

To maintain electromagnetic interference (EMI) within certified limits, the BladderScan BVI 9600 system must be used with the cables, components, and accessories specified or supplied by Verathon®. For additional information, see the [System Components & Accessories](#) and [Component Specifications](#) sections. The use of accessories and/or cables other than those specified or supplied may result in increased emissions and/or decreased immunity of the system.

The BladderScan BVI 9600 system should not be used adjacent to or stacked with other equipment. If adjacent or stacked use is necessary, the system should be observed to verify normal operation in the configuration in which it will be used.

This device can radiate radio frequency energy and is very unlikely to cause harmful interference with other devices in the vicinity. There is no guarantee that interference will not occur in a particular installation. Evidence of interference may include degradation of performance in this device or other devices when operated simultaneously. If this occurs, try to correct the interference by using the following measures:

- Turn devices on and off in the vicinity to determine the source of interference
- Reorient or relocate this device or other devices
- Increase the separation between devices
- Connect the device to an outlet on a circuit different than the other device(s)
- Eliminate or reduce EMI with technical solutions (such as shielding)
- Purchase medical devices that comply with IEC 60601-1-2 EMC Standards

Be aware that portable and mobile radio frequency communications equipment (cellular phones, etc.) may affect medical electrical equipment; take appropriate precautions during operation.

## WARNINGS



### WARNING

The BladderScan 9600 in AortaScan® mode is not a diagnostic or screening device. If clinically indicated, appropriate patients should be referred for a diagnostic standard (confirmatory) test, regardless of test results.



### WARNING

The BladderScan 9600 in AortaScan mode is designed to detect the fluid (blood) filled region of the abdominal aorta only. The AortaScan cannot detect the presence of a blood clot (thrombus) and therefore may provide a false negative result.



### WARNING

The BladderScan 9600 in AortaScan® mode is an ultrasound-based device and is subject to all limitations of this method. If clinically indicated, appropriate patients should be referred for a diagnostic standard (confirmatory) test, regardless of test results.



### WARNING

**Risk of explosion.** If you use the BladderScan BVI 9600 in the presence of flammable anesthetics, the hazard of potential explosion exists.



### WARNING

**Risk of electric shock or burns.** Do not use the BladderScan instrument in conjunction with HF surgical equipment.



### WARNING

**Potential patient hazard.** To date, exposure to low-power, pulsed diagnostic ultrasound has not been shown to produce adverse effects. However, medical professionals should use ultrasound only when clinically indicated, using the lowest exposure times possible to obtain proper measurements. The ultrasonic output of the BladderScan BVI 9600 is not user adjustable and is limited to the minimum level necessary for effective performance. For more information about the acoustic output levels of this device, see the chapter [Product Specifications](#) on page 80.



### WARNING

**Ensure proper distance from patient.** When transmitting data to or from your computer, make sure the BladderScan BVI 9600, accessories, and computer are outside the patient vicinity (more than six feet [2 meters] from the patient).



### WARNING

Do not use the BladderScan BVI 9600 on:

- A patient who has open skin or wounds in the mid-abdominal area.
- A patient with ascites.
- A pregnant patient.



## WARNING

**Risk of inaccurate measurements/results.** When using the instrument, be aware of the following conditions that can decrease the accuracy of exam results.

- In some cases, the normal operating tolerances of the instrument can cause it to report a falsely normal or abnormal measurement in AortaScan® Mode. For more information, see [Interpret the Aortic Measurement Results](#) on page 61.
- Visual verification that the aorta position is fully within the scan cone on the displayed images is important while in the AortaScan Mode.
- A thrombus (blood clot) can complicate aortic measurements. A soft, blood-like thrombus may appear as part of the lumen. However, a calcified thrombus may appear as part of the aorta's wall, resulting in a measurement of lumen diameter that is smaller than the aorta diameter. Accordingly, in patients where thrombus is known or suspected, other imaging methods should be used prior to ruling out an aneurysm.
- Use care when scanning patients who have had suprapubic or pelvic surgery. Scar tissue, surgical incisions, sutures, and staples can affect ultrasound transmission and accuracy.
- A catheter in the patient's bladder may affect the accuracy of the bladder volume measurement in two ways: 1) by introducing air into the bladder that may block the ultrasound signal, and 2) by having the catheter-retaining balloon interfere with the volume measurement. However, the volume measurement may still be clinically useful if it is large (detecting a blocked catheter, for example).
- Ensure that the patient fasts for 12 hours prior to undergoing an aortic diameter measurement in order to minimize the presence of bowel gas, which may obstruct proper measurement.
- Obesity may affect ultrasound bladder volume measurements and aortic diameter measurements. Lift as much abdominal adipose tissue out of the way of the instrument as possible. Apply more pressure to the probe to reduce the amount of adipose tissue through which the ultrasound must pass. For more information about obesity when measuring abdominal aortic diameter, see [Obesity](#) on page 64.

Accuracy is compromised if the user does not obtain an optimal, repeatable image.



## WARNING

**Risk of explosion, fire, or serious injury.** The BladderScan BVI 9600 is powered by a lithium-ion battery. Failure to note the following when handling the battery may result in serious injury:

- Never short-circuit the battery by either accidentally or intentionally bringing the battery terminals into contact with any other conductive object. This could cause serious injury or fire and could also damage the battery and the BladderScan device.
- Never expose the battery to abnormal shock, vibration, or pressure. The battery's internal protective covering could fail, causing it to overheat or ignite, resulting in caustic liquid leakage, explosion, or fire.
- Do not disassemble, heat above 60°C (140°F), or incinerate the battery. Keep battery out of reach of children and in original package until ready to use. Dispose of used batteries promptly according to local recycling or waste regulations.
- If the battery is leaking or its case is cracked, put on protective gloves to handle it, and discard it immediately. Always dispose of used batteries in compliance with all applicable laws and regulations. Put insulating tape, such as cellophane tape, on the electrodes during transportation in order to avoid a possible short circuit, fire, or electrical shock.



## WARNING

This product may only be cleaned and disinfected by using the approved processes provided in this manual. Cleaning and disinfection methods listed are recommended by Verathon® based on compatibility with component materials.



## WARNING

Availability of cleaning and disinfection products varies by country, and Verathon is unable to test products in every market. For more information, please contact Verathon Customer Care at 1.800.331.2313 or your local representative. For additional contact information, visit [verathon.com/contact-us](https://www.verathon.com/contact-us).



## WARNING

Ensure that you follow the manufacturer's instructions for handling and disposing of the cleaning and disinfection solutions provided in this manual.



## WARNING

Cleaning is critical to ensuring the component is ready for disinfection. Failure to properly clean the device could result in a contaminated instrument after completing the disinfection procedure.



# INTRODUCTION

---

## COMPONENTS & FEATURES

The BladderScan BVI 9600 is designed for simple, intuitive operation. However, to ensure safe and effective operation, before using the device:

- Familiarize yourself with the contents of this manual.
- Watch the training video provided on the instrument.

The BladderScan BVI 9600 has two main components: the console and the probe. The console and probe are linked by a detachable cable.

Figure 1. BladderScan BVI 9600 Components



## PROBE COMPONENTS

The probe transmits and receives ultrasound waves, automatically moving its internal transducer 360° to scan twelve planes to produce a three-dimensional image of the bladder. The probe is attached to the console by a detachable cable and has three main features:

Figure 2. Probe Components

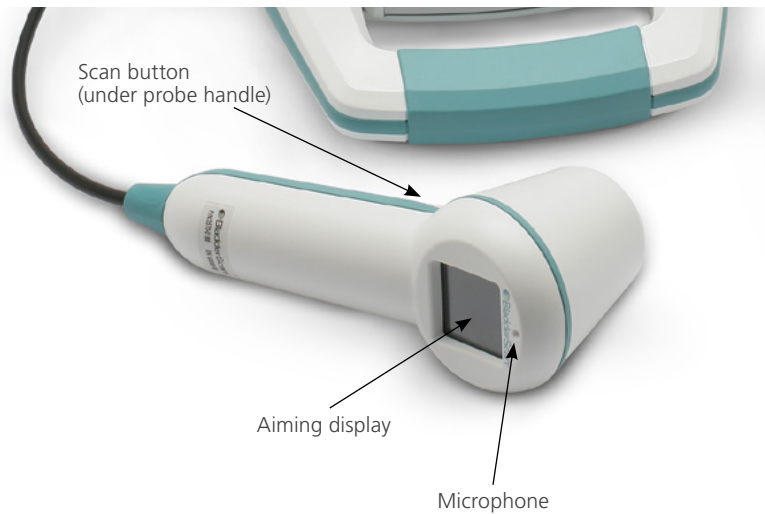

Table 2. Probe Components

PART NAME	PURPOSE
Scan button	Takes a scan when pressed.
Aiming display	Displays directional arrows to ensure the bladder is centered within the scanning cone.
Microphone	Records voice annotations.

## CONSOLE COMPONENTS

The console provides all operating controls for the scanning process by means of five variable function buttons. The measured bladder volume or aortic diameter and target-shaped aiming icons are clearly displayed on the console's LCD screen. The console also provides controls for adjusting brightness and volume, turning the power on/off, interfacing with a ScanPoint®-equipped computer (optional), and adjusting user settings and preferences. The console also houses the battery and the printer.

Figure 3. Console Components



Table 3. Console Components

PART NAME	PURPOSE
Main display	Displays the bladder volume measurement, patient type, settings, and instrument status.
Power on/off	Toggles main power on/off.
Volume	Adjusts volume up/down on voice annotation playback, start up sound, and "scan complete" tone.
Brightness	Adjusts display brightness dimmer/brighter.
Five variable function buttons	Provides access to all instrument functions for scanning, recording annotations, printing, connecting to ScanPoint (optional), accessing the training video, and setting user preferences.
Printer or printer door	Releases the printer door.

## BATTERY CHARGER/WIRELESS HUB COMPONENTS

The BladderScan BVI 9600 is powered by a lithium-ion battery. The battery charger provided with the BVI 9600 can charge two Li-Ion batteries while simultaneously functioning as the wireless hub linking the BVI 9600 to the ScanPoint® host computer. A battery icon on the instrument display is always present, indicating battery status. The user can change the battery whenever necessary. Removing a discharged battery and replacing it with a fresh battery will not erase any saved exams or user settings.

To provide power to the batteries, the battery charger/wireless hub must be plugged into a wall outlet using the power cord provided. Use only the battery charger provided with the BVI 9600. Any other battery charger may damage the battery. The battery charger automatically detects whether a lithium-ion battery is being charged.

To provide wireless communication between the BVI 9600 and the ScanPoint® host computer, plug the battery charger/wireless hub USB connector into a USB port on the ScanPoint host computer. The battery charger/wireless hub maintains an operating distance of up to 120 feet (36 meters) between the ScanPoint computer and the BVI 9600, regardless of barriers such as walls, ceilings, or windows.

*Note: Use of ScanPoint with QuickPrint software is optional.*

Figure 4. Battery Charger/Wireless Hub



Table 4. Battery Charger/Wireless Hub Components

PART NAME	PURPOSE
Battery charger/wireless hub	Charges the lithium-ion batteries and receives and sends information to/from a BVI 9600 instrument within communication range.
Lithium-ion battery	When charged, provides power to the BVI 9600 device.
Power cord	Connects the battery charger/wireless hub to the wall outlet.
Wireless hub USB cable	Connects the battery charger/wireless hub to the ScanPoint host computer.

## SYSTEM COMPONENTS & ACCESSORIES

Table 5. Components and Accessories

COMPONENTS
BVI 9600 console
BVI 9600 probe
Battery charger/wireless hub with AC power cord
Lithium-ion battery (2 provided)
ACCESSORIES
BladderScan BVI 9600 In-Service CD or USB, containing the Operations & Maintenance Manual
Thermal paper roll for the printer
Replacement lithium-ion battery
Ultrasound gel
Mobile cart (Optional)
Universal accessory basket (Optional)
ScanPoint with QuickPrint software install CD (Optional)
ScanPoint® with QuickPrint user's manual (Optional)
Calibration kit (Includes calibration container, calibration target, etc.) (Optional)















To order any of the above parts or accessories, contact your authorized Verathon® sales representative or contact Verathon Customer Care.

## ICONS & BUTTONS















The console LCD presents user information and prompts that vary depending on the current device function. The five buttons below the display have variable functions according to device mode. Button functions are indicated by icons in the display footer, immediately above each button.







### CONSOLE DISPLAY ICONS

The following icons may appear on the console main display.

ICON	PURPOSE
	A fully-charged battery.
	A battery 50% to 75% charged.
	A battery 25% to 50% charged.
	Nearly depleted battery.
	A fully discharged battery. Replace immediately.
	Scan mode for patients who are female and have not had a hysterectomy.
	Scan mode for all other patients.
	AortaScan® mode.
	Empty exam folder.
	Current exam folder.
	Saved exam folder.
	The bladder is too large to be contained within the image cone (cone-shaped area in which the probe transmits ultrasound waves), or the bladder contains more than 999 ml of urine.
	The bladder is contained within the image cone, but not centered. You may be able to obtain a more accurate measurement by re-aiming the probe in the direction indicated by the arrow.
	The bladder is not contained within the image cone. You must re-aim and re-scan.

## VARIABLE BUTTON FUNCTIONS

ICON	PURPOSE
	<p>Single button with three modes. When performing an exam, press the button repeatedly until the desired setting appears above the saved exams folders:</p> <ul style="list-style-type: none"> <li>• Select the “female” icon to scan a female patient who has not had a hysterectomy.</li> <li>• Select the “BladderScan” icon to scan all other patients..</li> <li>• Select AortaScan® mode.</li> </ul>
	<p>Go to the Home screen.</p>
	<p>View the training video.</p>
	<p>Go to the Settings screen.</p>
	<p>Go to the Review screen. If there are no saved exams, this button is disabled.</p>
	<p>Initiate communication with the ScanPoint® host computer. Saved and annotated exams will be automatically uploaded to the host computer.</p> <p><i>Note: ScanPoint software must be previously installed and the computer connected to the wireless hub. Use of the ScanPoint software is optional.</i></p>
	<p>Record a voice annotation.</p>
	<p>Play a previously recorded voice annotation. If no voice annotations are recorded, this button is disabled.</p>
	<p>Print exam results from the onboard printer. While printing is in progress, an hourglass icon appears on the display, and most buttons are disabled.</p>
	<p>Move down an item.</p>
	<p>Move up an item.</p>
	<p>Move right an item.</p>
	<p>Delete an exam or cancel the current action.</p>
	<p>Select the highlighted item.</p>

ICON	PURPOSE
	Stop recording a voice annotation.
	Play video playback.
	Pause video playback.
	Add and/or toggle characters, as appropriate.
	Remove and/or toggle characters, as appropriate.
	No function.

## BUTTON FUNCTIONS FOR EACH DISPLAY SCREEN

The Power, Brightness, and Volume buttons are constant buttons on the body of the console and can be pressed at any time. The five buttons below the LCD have variable functions according to device mode. The Scan button is located on the underside of the probe.

SCREEN/MODE	ACTIVE BUTTONS
<b>Splash screen</b> Displays during boot-up to show the process is proceeding properly.	None
<b>Home screen</b> Appears when the instrument is turned on.	(1) <b>Patient mode</b> : toggle between three modes: small child, female with uterus, all other patients. (2) <b>Tutorial</b> : opens Tutorial screen. (3) <b>Settings</b> : opens Settings screen. (4) <b>Review</b> : opens the Review screen. (5) <b>ScanPoint®</b> : transmits saved exams to ScanPoint.
<b>Scan screen</b> Appears when the operator presses and releases the Scan button on the underside of the probe.  As bladder volume is calculated, the display refreshes and updates until the scan is complete.	Scan button: press and release to take a scan. (1) - (4): No function (5): <b>Home</b> : return to Home screen.



SCREEN/MODE	ACTIVE BUTTONS
<p><b>Results screen</b></p> <p>Appears when a scan is complete. Prominently displays calculated bladder volume, patient type, and available memory. An hourglass icon appears when the device is printing.</p>	<p>(1) <b>Record</b>: press to record, changes to a stop button during recording.</p> <p>(2) <b>Print</b>: print to onboard printer.</p> <p>(3) <b>Listen</b>: press to listen to the voice annotations, otherwise, no function.</p> <p>(4) <b>Review</b>: opens review screen if a voice annotation has been recorded; otherwise, no function.</p> <p>(5) <b>Home</b>: return to Home screen.</p>
<p><b>Review screen</b></p> <p>Appears to allow user to review saved exams. Saved exam folders are on the left side of the screen with the currently selected saved exam is an open folder icon. The ultrasound images associated with selected exam are on the main display.</p>	<p>(1) <b>Down Arrow</b>: select the next saved exam.</p> <p>(2) <b>Print</b>: print to onboard printer.</p> <p>(3) <b>Listen</b>: replay voice annotation for selected exam.</p> <p>(4) <b>Delete</b>: delete selected exam.</p> <p>(5) <b>Home</b>: return to Home screen.</p>
<p><b>Tutorial screen</b></p> <p>View the training modules menu.</p>	<p>(1) <b>Down Arrow</b>: skip to next video.</p> <p>(2) <b>Up Arrow</b>: select previous video.</p> <p>(3) <b>Select</b>: play selected video.</p> <p>(4) No function.</p> <p>(5) <b>Home</b>: return to Home screen.</p>
<p><b>Video Viewing screen</b></p> <p>Plays the selected tutorial video.</p>	<p>(1) No function.</p> <p>(2) <b>Play</b>: plays selected video, changes to a pause button when video is playing.</p> <p>(3) <b>Up Arrow</b>: return to Tutorial screen.</p> <p>(4) No function.</p> <p>(5) <b>Home</b>: return to Home screen.</p>
<p><b>Settings screen</b></p> <p>Start screen for editing clinic name, date &amp; time, general preferences, savings preferences, and self test options.</p>	<p>(1) <b>Down Arrow</b>: select next setting in list.</p> <p>(2) <b>Up Arrow</b>: select previous setting in list.</p> <p>(3) <b>Select</b>: proceed to the selected screen.</p> <p>(4) No function.</p> <p>(5) <b>Home</b>: return to Home screen.</p>
<p><b>Name screen</b></p> <p>Displays alpha numeric characters for entering information.</p>	<p>(1) <b>Down Arrow</b>: move to the character below.</p> <p>(2) <b>Right Arrow</b>: move to the character to the right.</p> <p>(3) <b>Plus Sign</b>: add currently selected character.</p> <p>(4) <b>Minus Sign</b>: delete currently selected character.</p> <p>(5) <b>Settings</b>: return to main settings screen.</p>

SCREEN/MODE	ACTIVE BUTTONS
<p><b>Date and Time screen</b> Allows the user to set the date and time.</p>	<p>(1) <b>Down Arrow</b>: move forward to next changeable unit.  (2) <b>Up Arrow</b>: move back to previous changeable unit.  (3) <b>Plus Sign</b>: add/toggle units.  (4) <b>Minus Sign</b>: decrease/toggle units.  (5) <b>Settings</b>: save current date/time entries and return to main settings screen.</p>
<p><b>General Preferences screen</b> List of available settings and their current values.</p>	<p>(1) <b>Down Arrow</b>: select next setting in list.  (2) <b>Up Arrow</b>: select previous setting in list.  (3) <b>Plus Sign</b>: select next option.  (4) <b>Minus Sign</b>: select previous option.  (5) <b>Settings</b>: return to Home screen.</p>
<p><b>Savings Preferences screen</b> Set preferences for UTI cost savings tracking.</p>	<p>(1) <b>Down Arrow</b>: select next setting in list.  (2) <b>Up Arrow</b>: select previous setting in list.  (3) <b>Plus Sign</b>: select next option.  (4) <b>Minus Sign</b>: select previous option.  (5) <b>Settings</b>: return to Home screen.</p>
<p><b>Self Test screen</b> Displays test progress and results.</p>	<p>(1) - (4): No function  (5) <b>Settings</b>: go back to Settings screen.</p>
<p><b>ScanPoint screen</b> Displays status information about the ScanPoint communication.  <i>Note: Available only when ScanPoint is installed on instrument.</i></p>	<p>(1) - (3): No function  (4) <b>Cancel</b>: cancels connection to ScanPoint®.  (5) No function.</p>

# DISPLAY SCREENS

## HOME SCREEN

The Home screen appears when the BladderScan is turned on. It serves as a starting point for all of the main functions of the device.

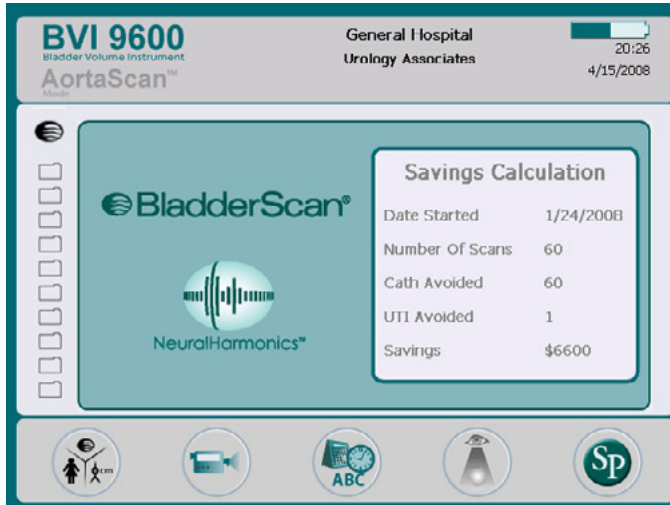





The Home screen displays:

- In the header: Your clinic’s name, the battery status indicator and current date and time.
- In the center panel, left side: A list of saved exam results (10 maximum) saved in chronological order. Yellow folders hold saved exams. Grey folders represent empty spaces still available for saving exam results.
- In the center panel, right side: A cost saving summary. Displays the savings to your organization due to using the BladderScan BVI 9600 rather than catheterization. The values used to calculate the savings are user-variable and are entered from the Savings Preference screen.
- In the footer: Five variable-function buttons.

Table 6. Battery Power Level

BATTERY ICON	POWER LEVEL
	Indicates a fully charged battery.
	Indicates a battery 50% to 75% charged.
	Indicates a battery 25% to 50% charged.
	Battery almost depleted.
	Replace immediately.

Table 7. Home Screen Button Functions

BUTTON	FUNCTION
	<p>Single button with three modes. When performing an exam, press the button repeatedly until the desired setting appears above the saved exams folders:</p> <ul style="list-style-type: none"> <li>• Select the “small child” icon to scan a patient less than 48 inches (122 cm) tall and weighing less than 60 lbs (27 kg).</li> <li>• Select the “female icon” to scan a female patient who has not had a hysterectomy.</li> <li>• Select the “BladderScan icon” to scan all other patients.</li> </ul>
	View the training video.
	Go to the Settings screen (set the time, date, institution name, and user preferences).
	Review a previously saved exam.
	<p>Initiate communication with the ScanPoint® host computer. Saved and annotated exams will be automatically uploaded to the host computer.</p> <p><i>Note: ScanPoint software must be previously installed and the computer connected to the wireless hub. Use of the ScanPoint software is optional.</i></p>

## SCAN SCREEN

The Scan screen appears after you press the **Scan** button on the underside of the probe and displays a progressively-updating image of the bladder outline. When the ultrasound measurement is complete, the Results screen opens automatically. Four of the five buttons below the display do not function during the scan.

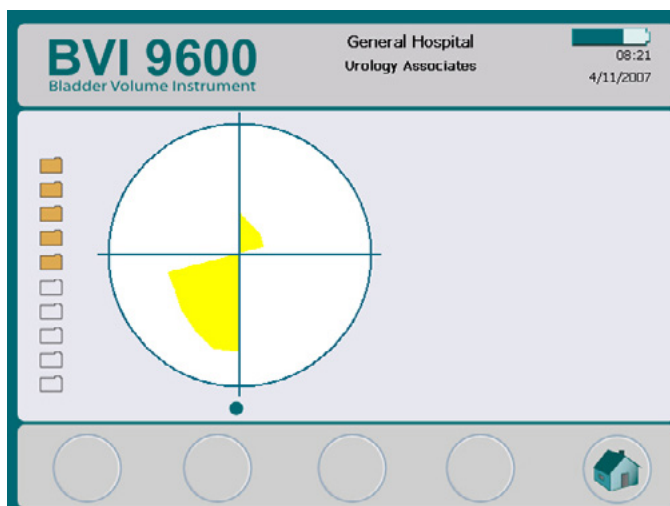

## RESULTS SCREEN

The Results screen appears automatically when an ultrasound scan is complete. The display presents the result of the exam: crosshairs, bladder outline, and the calculated bladder volume. You may choose to print this result to the onboard printer and/or to record a voice annotation to save the exam. After the annotation is recorded, the Play and Review buttons become active, and the newly recorded exam appears on the main display as an orange folder icon.

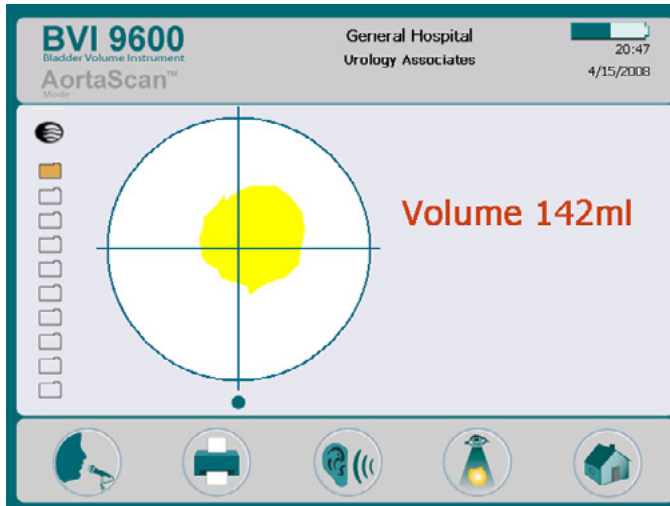







Table 8. Results Screen Button Functions

BUTTON	FUNCTION
	Record a voice annotation (up to 10 seconds long).
	Print exam results to the onboard printer.
	Play a previously recorded voice annotation. If no voice annotations are recorded, this button is disabled.
	Go to the review screen. If no voice annotations are recorded, this button is disabled.
	Return to the Home screen.

## REVIEW SCREEN

The Review screen opens when you select a saved exam (yellow folder icon) to review. The display shows the ultrasound images associated with the selected exam. A green open-folder icon indicates which exam is being viewed. While reviewing saved exams, the buttons below the display allow you to print, replay, or delete exam data.

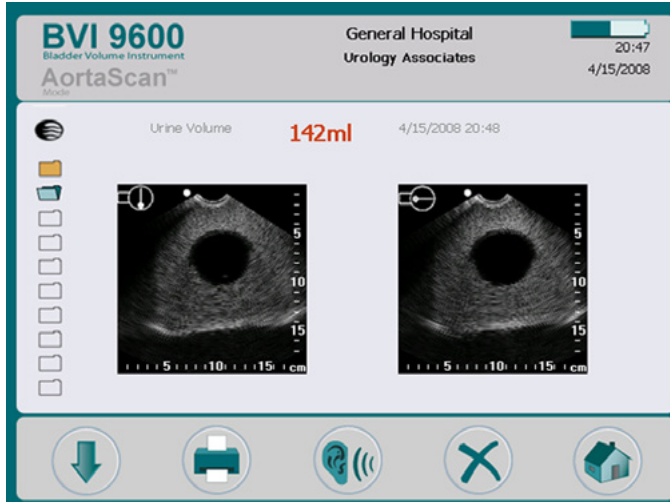

Table 9. Review Screen Button Functions









BUTTON	FUNCTION
	Select the next exam in the list.
	Print the results for the currently selected exam to the onboard printer. While printing is in progress an hourglass icon appears on the display, and all buttons are disabled except Select and Play.
	Play a previously recorded voice annotation. If no voice annotations are recorded, this button is disabled.
	Delete the currently selected exam.
	Return to the Home screen.

Table 10. Ultrasound Icons

ICON	DESCRIPTION
	Sagittal orientation marker in the B-mode displayed in review and on the printed results.
	Transverse orientation marker in the B-mode displayed in review and on the printed results.

## TUTORIAL SCREEN

To open the Tutorial screen, press the **Tutorial** button  from the Home screen. The Tutorial screen presents a menu of training modules.

*Note: When this screen is open, the Scan button on the probe is disabled.*

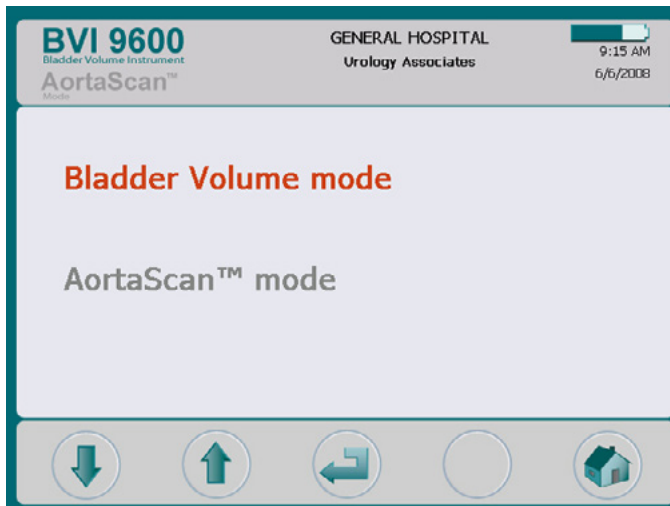







Table 11. Tutorial Screen Button Functions

BUTTON	FUNCTION
	Move down one title or skip back one chapter in the training module.
	Move up one title or skip forward one module.
	Begin module playback. While the module is playing, press to pause. Press again to resume play.
	No function.
	Return to the Home screen.

## VIDEO VIEWING SCREEN

The Video Viewing screen is activated by pushing the **Enter** button  on the Tutorial screen.

Press the **Play** button  to begin the desired tutorial.

*Note: When this screen is open, the Scan button on the probe is disabled.*

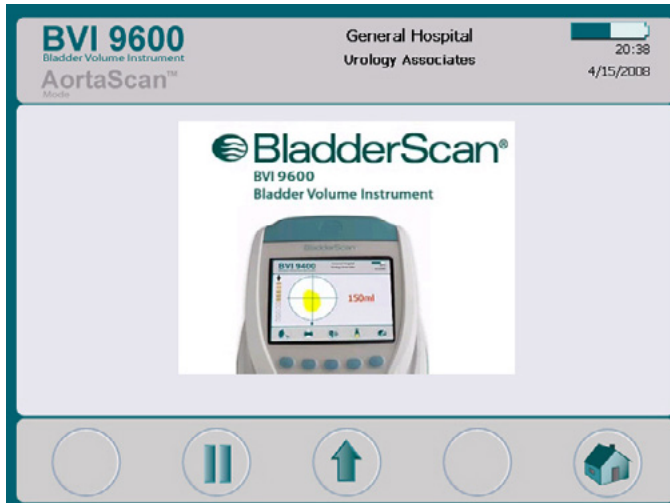







Table 12. Video Viewing Screen Button Functions

BUTTON	FUNCTION
	No function.
	Play or pause video playback.
	Return to the screen showing the list of titles.
	No function.
	Return to the Home screen.



## SETTINGS SCREEN

To open the Settings screen, push the **Settings** button  on the Home screen. The display presents a list of user-configurable settings: Name, Time & Date, General Preferences, Savings Preferences, and Self Test.

*Note: When this screen is open, the scan button on the probe is disabled.*

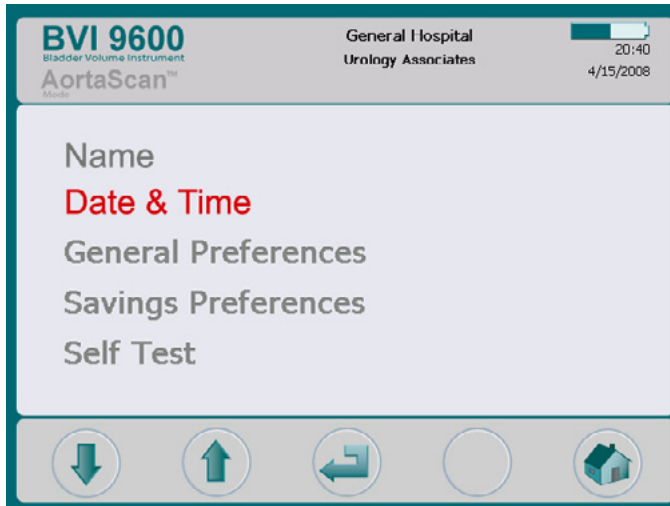







Table 13. Settings Screen Button Functions

BUTTON	FUNCTION
	Move down one setting in the list.
	Move up one setting in the list.
	Select the highlighted setting.
	No function.
	Return to the Home screen.

## NAME SCREEN

This screen allows you to select the appropriate alpha numeric characters for entering your health care institution's name.

See the section [Program the Clinic Name](#) for more information on this setting.

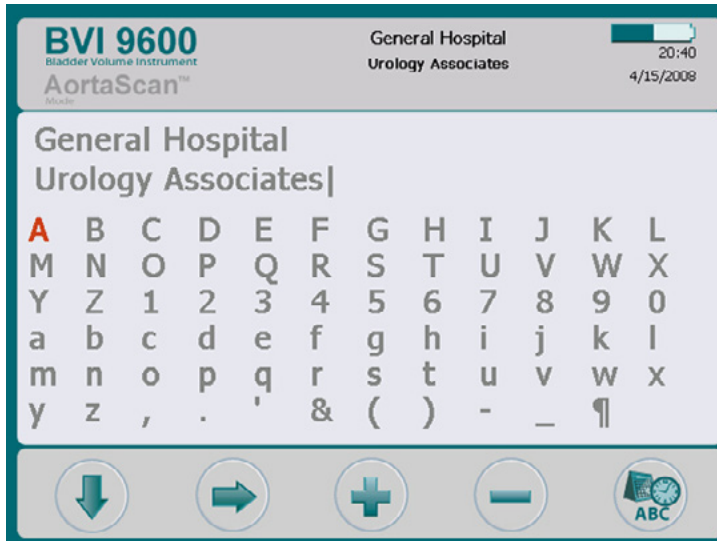







Table 14. Name Screen Button Functions

BUTTON	FUNCTION
	Move down in the grid.
	Move right in the grid.
	Add the highlighted character to the name.
	Delete one character from the name.
	Save the current name setting and return to the Settings screen.

## DATE AND TIME SCREEN

This screen allows you to adjust the date and time.

See the section [Set the Date and Time](#) for more information.

*Note: If the time display is set to show a 24-hour clock, the hour units are 0–23. If the clock is set to show a 12-hour clock, the hour units are 1 AM–12 AM and 1 PM–12 PM.*

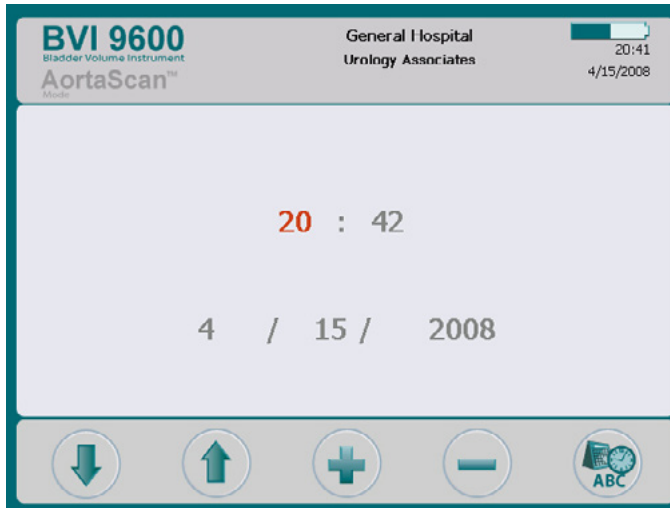







Table 15. Date and Time Screen Button Functions

BUTTON	FUNCTION
	Move back one changeable unit.
	Move forward to the next changeable unit.
	Add and/or toggle digits as appropriate. Press and hold the button to move through options more quickly.
	Subtract or toggle digits as appropriate. Press and hold the button to move through options more quickly.
	Save the current date and time settings and return to the Settings screen.

## GENERAL PREFERENCES SCREEN

This screen displays a list of available settings and their current values.

Available settings:

- **Language:** Multiple languages are available. English is the default setting.
- **Date Format:** mm/dd/yyyy; dd.mm.yyyy; yyyy-mm-dd.
- **Time Format:** 12-hour or 24-hour.
- **Calibration Warning:** On (default), Off. When "On" is selected, a calibration warning will appear in the display header when the device requires calibration.
- **Enable Small-Child Mode (SCM):** On (default), Off. Select "Off" to disable Small-Child Mode.  
*Note: If use of the small-child mode is rare in your practice, you may want to turn that option off.*
- **Print Report Type:** Toggle between C-mode images (bladder in cross and B-mode images).
- **Enable ScanPoint®:** On (default), Off. Select "Off" to disable ScanPoint.

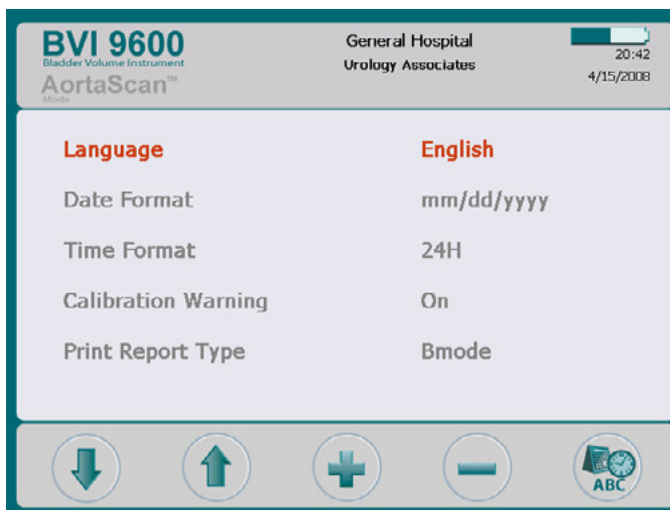
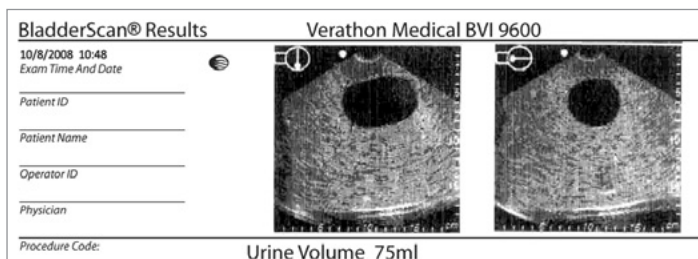
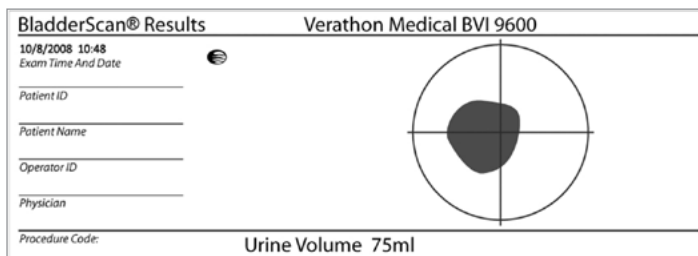

Figure 5. B-Mode and C-Mode Print Reports for BladderScan Mode



B-mode print report



C-mode print report

Figure 6. B-Mode and C-Mode Print Reports for AortaScan® Mode

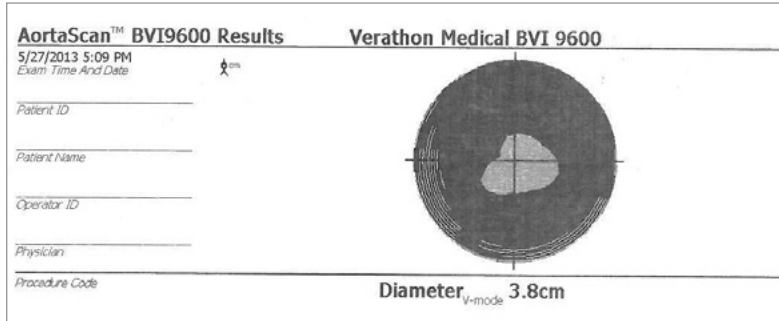



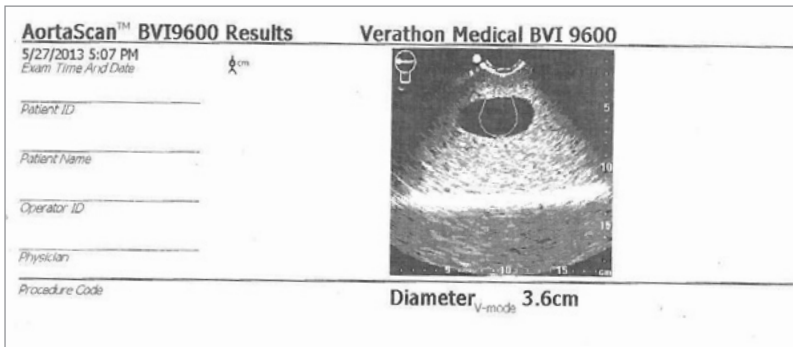

B-mode print report



C-mode print report

Table 16. General Preferences Screen Button Functions

BUTTON	FUNCTION
	Move down a setting in the list.
	Move up a setting in the list.
	Select the next option. Press and hold to move through options more quickly.
	Select the previous option. Press and hold to move through options more quickly.
	Save the current settings and return to the Setup screen.

## SAVINGS PREFERENCES SCREEN

This screen is for the BladderScan mode only.

Use this screen to enter base values used to calculate the savings to your organization from using the BladderScan BVI 9600 rather than catheterization.











Preferences lists and options:

- **UTI Rate:** 1% to 100% in increments of 1%
- **UTI Cost:** \$10 to \$10,000 in increments of \$10
- **Cath Cost:** \$1 to \$1000 in increments of \$1
- **Cath Volume:** 20 ml to 1000 ml in increments of 20 ml
- **Currency:** \$ / € / £ / ¥
- **Savings Calculation:** Since New, Since XX/XX/20XX (indicates the last reset date), Reset Now, Print Since New, Print Recent, Hide Savings

For more cost savings information, see [Histogram of Cost Savings](#).



Table 17. Savings Preferences Screen Button Functions

BUTTON	FUNCTION
 	Move down a setting in the list.
 	Move up a setting in the list.
 	Select the next option. Press and hold to move through options more quickly.
 	Select the previous option. Press and hold to move through options more quickly.
 	Save the current settings and return to the Settings screen.

## SELF TEST SCREEN

When you open the Self Test screen, testing begins automatically. Once testing is complete, data on the screen are printed automatically to the instrument's onboard printer.

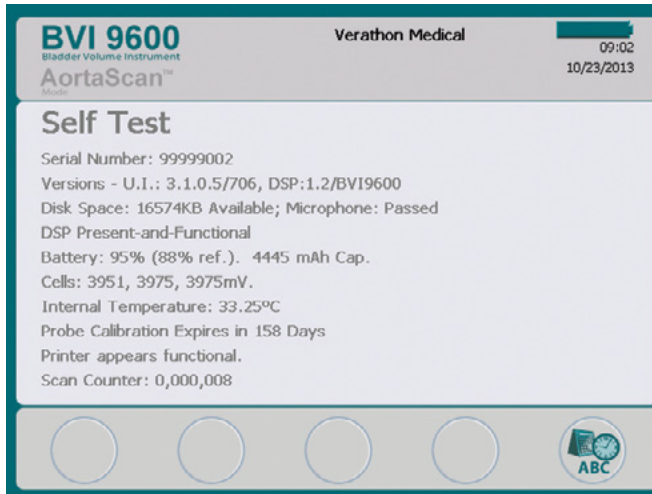







Table 18. Self Test Screen Button Functions

BUTTON	FUNCTION
	No function.
	No function.
	No function.
	No function.
	Return to the Setup screen.

### SCAN COUNTER FEATURE ON THE SELF TEST SCREEN

The BladderScan BVI 9600 is equipped with a scan counter feature. It counts all Scan button pushes captured by the console. It is designed to enable clinical users or service technicians to determine the number of scans the device has performed over its lifetime. It counts all scans taken with the instrument, including air scans and practice scans. The counter advances automatically after each scan.

Please note that the scan counter feature is available only with software version 3.1.0.0 or higher. Some BladderScan consoles cannot be upgraded to run software version 3.0 or higher. Software updates may be performed by either logging on to ScanPoint® or by contacting Verathon® Customer Care at 800.331.2313 or +1.425.867.1348.

The scan counter may be monitored as a part of a regular device maintenance program. The number of scans appears as a value on the self test screen and the self-test printout.

To ensure reliability, a backup copy of the scan count is stored in device memory. If both the scan counter and its backup copy are corrupted, the scan counter will automatically reset to a zero value.

The scan counter feature is designed so that the value cannot be manually reset or modified by the clinical user or service partner.

## VIEWING THE SCAN COUNTER

The scan counter can be viewed on the Self-Test screen.

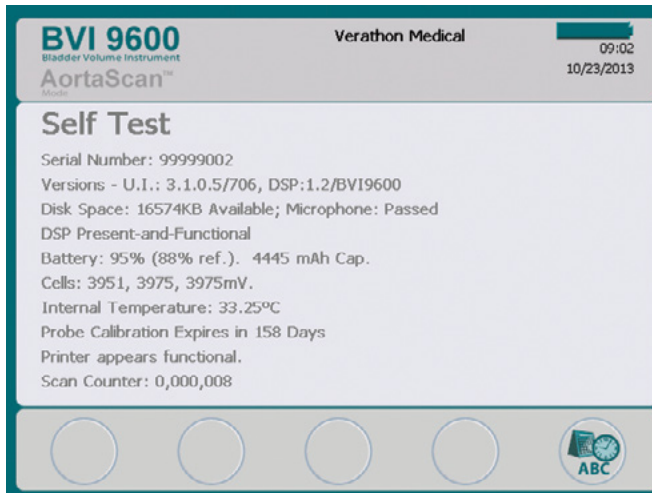

## PRINTING THE SCAN COUNT FROM THE SELF TEST SCREEN

Once the self test screen is accessed, data on the screen are printed automatically using the instrument's onboard printer.

Figure 7. Printout of Self Test Results

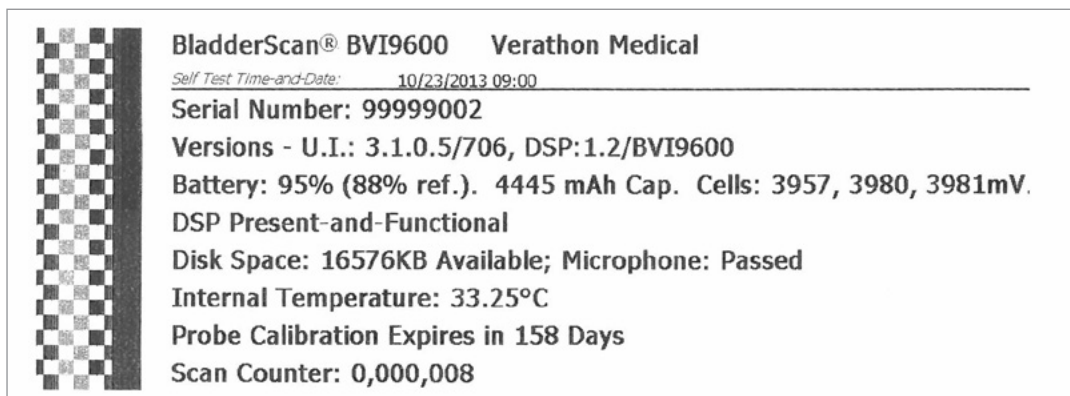



## TROUBLESHOOTING

The scan counter feature is designed for redundancy, so the scan value is stored in multiple locations in the instrument's internal memory. If one of the storage locations fails, the text "EEPROM Failed" will be added to the DSP status line. In the event of an EEPROM failure, the counter will continue to work but will not have a backup copy stored in the instrument.

Figure 8. Self Test Screen and Printout when EEPROM Has Failed

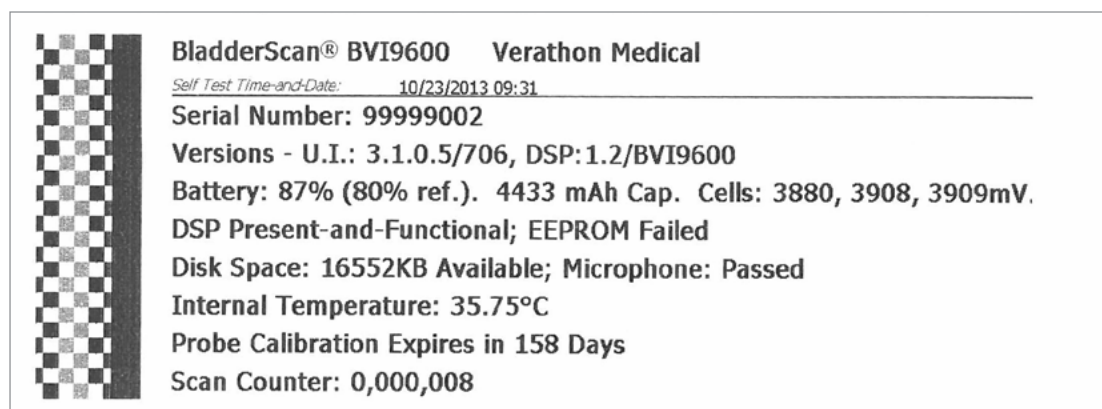
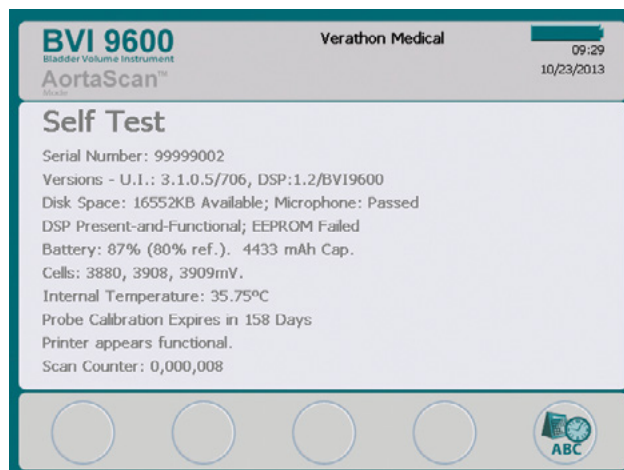

## SCANPOINT SCREEN

Note: This screen is only available if the optional ScanPoint® software is installed on a PC.

Press the **ScanPoint** button  on the Home screen. The ScanPoint screen displays information about the status of the link between the BladderScan instrument and the ScanPoint host computer.

Figure 9. ScanPoint® Screen (Searching)



Figure 10. ScanPoint Screen (Connected)

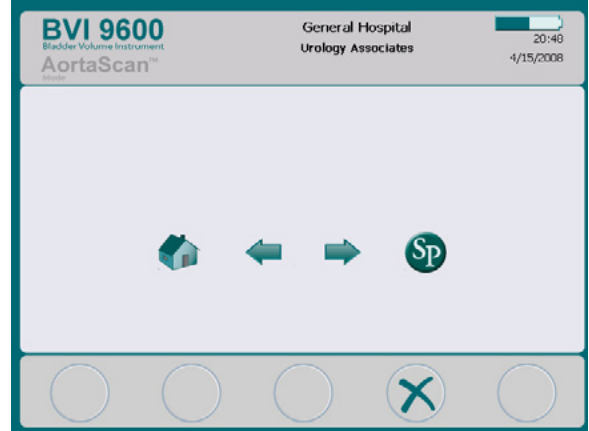







Table 19. ScanPoint Screen Button Functions

BUTTON	FUNCTION
	No function.
	No function.
	No function.
	Cancels the current action and ends communication with ScanPoint®.
	No function.

## SLEEP MODE

To conserve battery power, the BladderScan BVI 9600 goes into Sleep mode by shutting itself down automatically when not in use.

After four minutes of idle time, a Sleep mode alert message displays for 15 seconds. While the message is displayed, press any button to keep the console awake and dismiss the message. After 15 seconds, the console goes to sleep. To wake the instrument from Sleep mode, simply press the **Power** button .

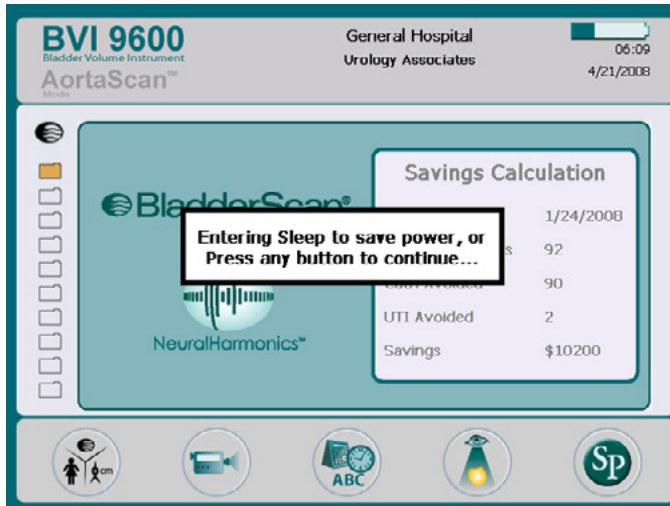

## HISTOGRAM OF COST SAVINGS

Each volume measurement from a completed scanning procedure is stored in the memory of the BladderScan BVI 9600 in one of eleven volume ranges (each with a 100 ml increment). This data is analyzed and can be displayed on the BVI 9600 at any time. The Savings Preferences screen lists: Date Started, Number of Scans, Cath Averted, UTI (urinary tract infection) Avoided, Savings.

## COST SAVINGS CRITERIA

Cost savings are based on the following criteria:

- Catheterizations avoided: Urinary catheterization is deemed unnecessary. Thus, by using the BVI 9600, these catheterizations are avoided. The default setting (for volume below which catheterization is unnecessary) is 200 ml.
- UTIs avoided: Studies indicate that a certain percentage of catheterizations lead to UTIs.  
*Note: By avoiding unnecessary catheterizations, the resulting UTIs are thereby avoided. The default setting (for percent of catheterizations leading to UTIs) is 3%.*
- Average associated UTI cost: The default setting is \$1870 per patient.
- Average cost of catheter kits: The default setting is \$100 per kit.
- Total cost savings from using the BVI 9600 = (Catheterizations avoided x catheter costs) + (UTIs avoided x UTI costs)

*NOTE: The default settings can be customized to reflect the rates and costs at your facility by pressing the **Settings** button , then select Savings Preferences. See [Savings Preferences Screen](#) for more information on customizing savings preferences.*

# SETTING UP

---

To help you get up and running as quickly as possible, the next few pages explain how to:

1. [Perform the Initial Inspection](#)
2. [Set Up the Battery](#)
3. [Attach the Probe to the Console](#)
4. [Program the Clinic Name](#)
5. [Set the Date and Time](#)
6. [Load the Thermal Paper](#)
7. [Attach the Instrument to a Medical Cart \(Optional\)](#)
8. [Install ScanPoint with QuickPrint \(Optional\)](#)
9. [Watch the Training Video](#)

---

## PROCEDURE 1. PERFORM THE INITIAL INSPECTION

---

When you receive the BladderScan BVI 9600 system, Verathon® recommends that an operator familiar with the instrument perform a full visual inspection of the system for any obvious physical damage that may have occurred during shipment.

1. Carefully open the top flaps of the shipping box. Do not insert anything sharp through the top of the box.
2. Remove the contents and verify that you have received the appropriate components for your system.
3. Inspect the components for damage.
4. If any of the components are missing or damaged, notify the carrier and Verathon Customer Care or your local representative.

---

## PROCEDURE 2. SET UP THE BATTERY

---



### WARNING

**Risk of explosion, fire, or serious injury.** The BladderScan BVI 9600 is powered by a lithium-ion battery. Failure to note the following when handling the battery may result in serious injury:

- Never short-circuit the battery by either accidentally or intentionally bringing the battery terminals into contact with any other conductive object. This could cause serious injury or fire and could also damage the battery and the instrument.
- Never expose the battery to abnormal shock, vibration, or pressure. The battery's internal protective covering could fail, causing it to overheat or ignite, resulting in caustic liquid leakage, explosion, or fire.
- Do not disassemble, heat above 60°C (140°F), or incinerate the battery. Keep battery out of reach of children and in original package until ready to use. Dispose of used batteries promptly according to local recycling or waste regulations.
- If the battery is leaking or its case is cracked, put on protective gloves to handle it, and discard it immediately. Always dispose of used batteries in compliance with all applicable laws and regulations. Put insulating tape, such as cellophane tape, on the electrodes during transportation in order to avoid a possible short circuit, fire, or electrical shock.



### WARNING

**Ensure proper distance from patient.** When transmitting data to or from your computer, make sure the BladderScan BVI 9600, accessories, and computer are outside the patient vicinity (more than six feet [2 meters] from the patient).

Two lithium-ion batteries are included with the BladderScan BVI 9600. One battery can be recharged in the battery charger/wireless hub while the other is installed in the BladderScan instrument. This ensures there is no instrument downtime. The charger will bring the batteries to a full charge within 6 hours or less. Before using the BladderScan BVI 9600 for the first time, you will need to charge both batteries.

The BladderScan BVI 9600 draws very little power when it is turned off. However, if you do not plan to use the BladderScan instrument for several weeks, you should remove the battery to prevent it from discharging. When batteries are not in use, they should be stored in the battery charger so they remain fully charged.

### CHARGE THE BATTERIES

1. Plug the battery charger/wireless hub unit into a standard wall outlet.
2. Insert the battery into the recess in the battery charger.

*Note: Fully charging the battery may take up to 6 hours. Batteries may be stored in the charger. There is no danger of overcharging the batteries.*





3. Check the colored indicator lights on the battery charger to determine battery status:

**Solid green:** Battery fully charged.

**Amber:** Battery charging.

The battery status indicator remains in the top right corner of the screen and indicates the charge level of the battery.

Table 20. Battery Power Level

BATTERY ICON	POWER LEVEL
	Indicates a fully charged battery.
	Indicates a battery 50% to 75% charged.
	Indicates a battery 25% to 50% charged.
	Battery almost depleted.
	Replace immediately.

#### INSERT A BATTERY INTO THE INSTRUMENT

4. Insert the charged battery into the battery well in the console, slide it under the ledge and push down gently until the battery clicks into place.

*Note: The battery is designed to prevent incorrect installation. If the battery does not slide into the battery well easily, remove the battery, reorient it, and try again. Do not attempt to force the battery into position.*

---

### PROCEDURE 3. ATTACH THE PROBE TO THE CONSOLE

---

1. Locate the cable port on the back of the console.



2. Align the silver arrow on the probe cable connector to the top of the cable port.



3. Gently push the connector ring into the port, until the cable clicks into place and is secure.

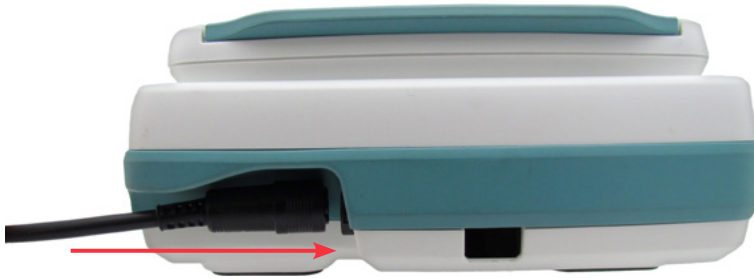



The cable can remain attached to the console in between uses.



*Note: To remove the cable, pull the connector ring back until the cable disconnects. Do not pull on the cable.*

## PROCEDURE 4. PROGRAM THE CLINIC NAME

You can customize your BladderScan BVI 9600 by entering your facility's name. This information will subsequently be included on BladderScan displays and all printouts of exam results.

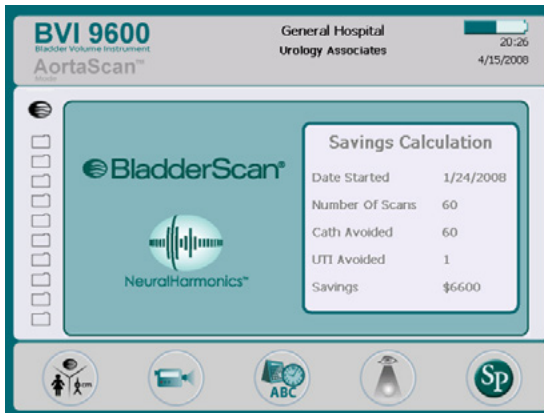



1. Turn the BladderScan BVI 9600 on by pressing the **Power** button  on the front of the console.
2. When the Home screen appears, press the **Settings** button  to open the Settings screen.

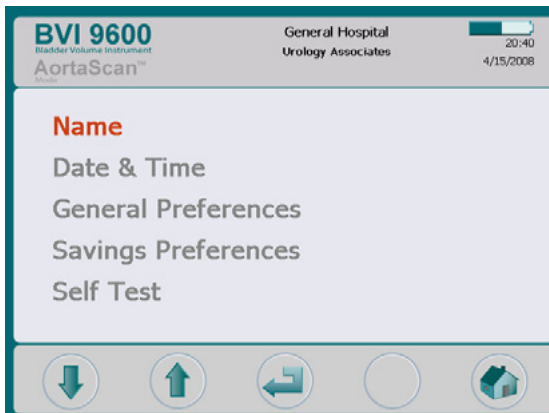

3. On the Settings screen, push either the **Up Arrow** button  or **Down Arrow** button  until "Name" is highlighted in red. Press the **Enter** button  to open the Name screen.







- On the Name screen, use the **Right Arrow** button  and **Down Arrow** button  to move to the desired character. When the desired character is highlighted in red, press the **Plus** button  to add it to your text. Use the **Minus** button  to delete characters.

To add a space between words, press the blank space below the letter x.

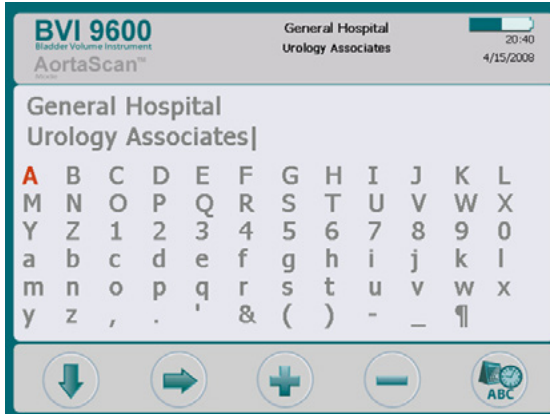



To add a second line of text use the ¶ character







- When finished, press the **Settings** button  to return to the Settings screen. From the Settings screen, press the **Home** button  to return to the Home screen. The facility name will now appear in the display header.

*Note for extended-Latin and/or non-Latin characters: Extended Latin characters (tilde, umlaut, accents, circumflex, etc.) and/or non-Latin characters can be entered only by using ScanPoint® with QuickPrint software. To enter a name that uses extended or non-Latin characters, please refer to the instructions in the ScanPoint with QuickPrint User's Manual.*

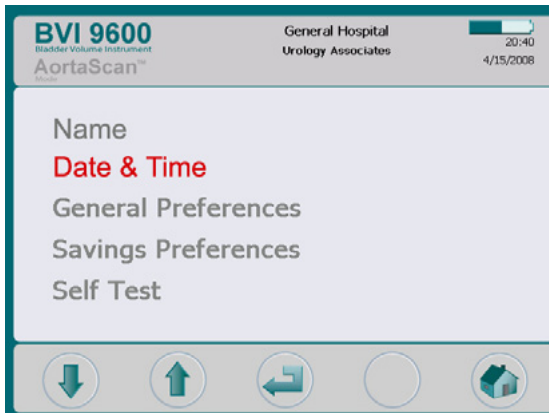
## PROCEDURE 5. SET THE DATE AND TIME

1. Turn on the device by pressing the **Power** button .
2. From the Home screen, press the **Settings** button  to open the Settings screen.
3. On the Settings screen, push either the **Up Arrow** button  or **Down Arrow** button  until "Date & Time" is highlighted in red. Press the **Enter** button  to open the Date & Time screen.



4. On the Date & Time screen, use the **Up Arrow** button  and **Down Arrow** button  to move to the desired unit (hours, minutes, month, day, year). When the desired unit is highlighted in red, press the **Plus** button  to increase values and the **Minus** button  to decrease values.

*Note: If the time display is set to show a 24-hour clock, the hour units are 0–23. If the clock is set to show a 12-hour clock, the hour units are 1-12.*

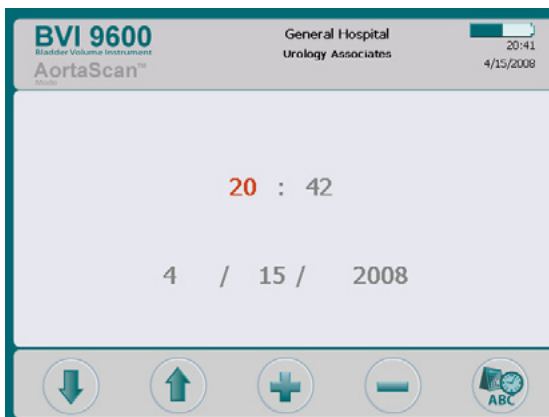

5. When the time and date are set correctly, press the **Settings** button  to return to the Settings screen. From the Settings screen, push the **Home** button  to return to the Home screen.

---

## PROCEDURE 6. LOAD THE THERMAL PAPER

---

If paper appears to be stuck in the printer, see the procedure [Clear a Paper Jam](#) on page 78.

1. Locate the paper compartment door on the base of the console, behind the display.
2. Slide the door to the right, then lift up.
3. If there is an empty paper roll, remove it.
4. In the paper well, insert the end of a new paper roll with the thermal side down.

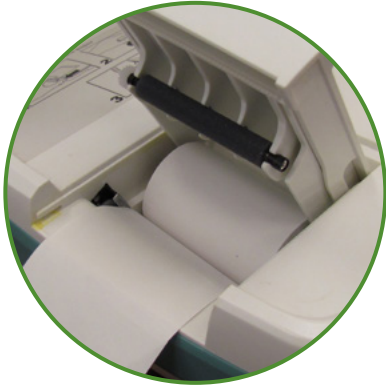

5. Extend the end of the paper past the side of the unit.
6. Snap the door completely closed, then slide the door back into the console.
7. Tear off any paper extending from the back of the console.

## PROCEDURE 7. ATTACH THE INSTRUMENT TO A MEDICAL CART (OPTIONAL)

The BladderScan BVI 9600 is completely portable and can be easily moved and positioned for convenient use. Installing the BVI 9600 on the optional mobile cart will allow you to move the BladderScan along with related accessories to the patient-examining area or bedside, as desired.

Figure 11. Assembled Medical Cart



Figure 12. Medical Cart Assembly

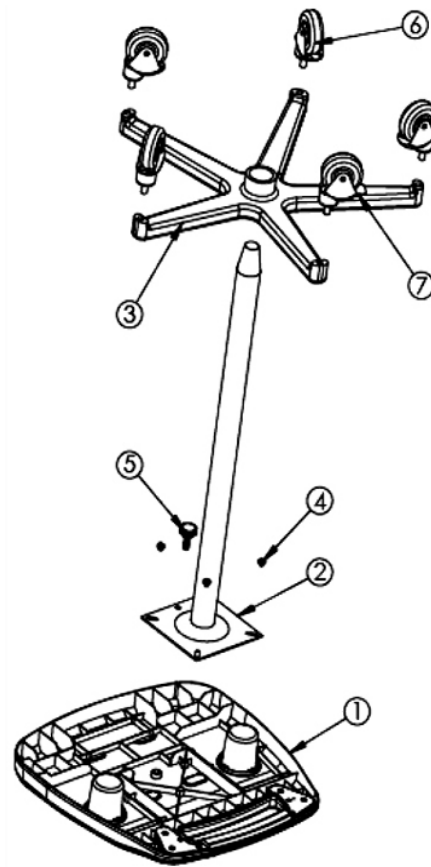

Table 21. Medical Cart Parts List

ITEM	QTY	PART
1	1	Medical tray
2	1	Post
3	1	Medical cart base
4	4	Screw PH W Lock 25-20 x 1/2
5	1	Fluted knob 3/8-16 x 1.00
6	3	Caster, 3 inch
7	2	Caster, 3 inch with brake
—	2	Loctite® 680 retaining compound (not pictured)

## ASSEMBLE THE MEDICAL CART

1. Insert the five casters into the medical cart base, positioning the brake casters on opposite ends of the base.
2. Insert the post into the square relief on the underside of the medical tray.
3. Insert the four screws through the bracket on the top of the post into the molded inserts in the medical tray and tighten securely.
4. If you want to permanently attach the post to the wheeled base, refer to Step 6 through Step 11.  
If you want the ability to disassemble the medical cart at a later date, place the tray assembly with the post into the wheeled medical cart base without applying any adhesive.
5. Place the BladderScan instrument into the footprints on the medical tray.  
If you want to secure the instrument to the medical cart, refer to Step 13 through Step 15.

## PERMANENTLY ATTACH THE POST TO THE WHEELED BASE (OPTIONAL)

6. Place medical cart base on level floor.
7. Open 2 tubes of Loctite® 680 by snapping off the tips of the tubes.
8. Apply the Loctite 680 all around the tapered portion of the post. Use all of the contents of both tubes. Complete coverage around the tapered portion is not necessary as the Loctite will spread upon insertion into the base.
9. Slide the post into the hole in the base with a twisting motion and press down firmly.
10. Wipe off excess Loctite with paper towel and discard towel as waste.
11. Allow post and base to sit undisturbed for 3 hours.

## ATTACH THE ACCESSORY BASKET (OPTIONAL)

A universal accessory basket is available for the medical cart to provide additional storage capacity.

12. Follow the manufacturer's instructions for attaching the accessory basket to the pole.

Figure 13. Universal Accessory Basket



## ATTACH THE INSTRUMENT TO THE MEDICAL CART (OPTIONAL)

13. Place the BVI 9600 atop the cart, aligning the rubber pads on the bottom of the device to the corresponding indentations on the tray.
14. On the bottom of the tray, insert the fluted knob into the mounting hole in the center.
15. Screw the fluted knob into the mounting hole until the device is secure on the tray.

Figure 14. Attach the Instrument to the Medical Cart

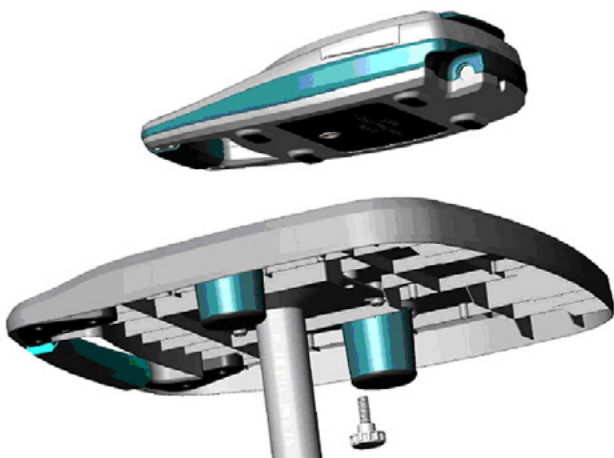

---

## PROCEDURE 8. INSTALL SCANPOINT WITH QUICKPRINT (OPTIONAL)

---

The optional ScanPoint® with QuickPrint software is designed to work seamlessly with your BladderScan devices. The BVI 9600 automatically downloads exam data to the ScanPoint host computer via a wireless connection enabled by the battery charger/wireless hub, allowing further viewing, analysis, archiving, and report generation.

To install the ScanPoint with QuickPrint software, insert the ScanPoint with QuickPrint install CD into your computer's CD drive and follow the on-screen prompts. Please refer to the separate operations and maintenance manual provided with ScanPoint with QuickPrint software for complete installation and operating instructions.

---

## PROCEDURE 9. WATCH THE TRAINING VIDEO

---

The training video provides an overview of how to perform an ultrasound scan of the bladder using the BladderScan BVI 9600. The video is:

- Approximately 5 minutes long.
- Available at the Verathon® Web site: [verathon.com](http://verathon.com)
- Available for review anytime on the instrument by pushing the **Tutorial** button  from the Home screen.

# USING THE DEVICE

## MEASURING BLADDER VOLUME



### WARNING

**Risk of explosion.** If you use the BladderScan BVI 9600 in the presence of flammable anesthetics, the hazard of potential explosion exists.



### WARNING

**Potential patient hazard.** To date, exposure to low-power, pulsed diagnostic ultrasound has not been shown to produce adverse effects. However, medical professionals should use ultrasound only when clinically indicated, using the lowest exposure times possible to obtain accurate measurements. The ultrasonic output of the BladderScan BVI 9600 is not user adjustable and is limited to the minimum level necessary for effective performance. For more information about the acoustic output levels of this device, see the chapter [Product Specifications](#) on page 80.



### WARNING

**Risk of inaccurate measurements/results.** When using the instrument, be aware of the following conditions that can affect ultrasound transmission and decrease the accuracy of exam results.

- Use care when scanning patients who have had suprapubic or pelvic surgery. Scar tissue, surgical incisions, sutures, and staples can affect ultrasound transmission and accuracy.
- A catheter in the patient's bladder may affect the accuracy of the bladder volume measurement in two ways: 1) by introducing air into the bladder that may block the ultrasound signal, and 2) by having the catheter-retaining balloon interfere with the volume measurement. However, the volume measurement may still be clinically useful if it is large (detecting a blocked catheter, for example).
- Obesity may affect bladder volume measurements. Lift as much abdominal adipose tissue out of the way of the instrument as possible. Apply more pressure to the probe to reduce the amount of adipose tissue through which the ultrasound must pass.

Accuracy is compromised if the user does not obtain an optimal, repeatable image.



### WARNING

Do not use the BladderScan BVI 9600 on:

- A patient who has open skin or wounds in the suprapubic area.
- A patient with ascites.
- A pregnant patient.

---

## PROCEDURE 1. PREPARE FOR THE EXAM

---

1. Ensure you are familiar with the parts and functions of the instrument. For more information, see the [Introduction](#) chapter on page 9.
2. If you are a new BladderScan instrument user, Verathon® recommends you perform your first exam on a patient with a moderately full bladder rather than initially attempting to locate and scan a nearly empty bladder.
3. Check the instrument battery icon to ensure the battery has sufficient power.  
If the battery icon is  $\frac{1}{4}$  full or less, replace the battery with a freshly charged battery before proceeding. Ensure the instrument is off before you replace the battery. Place the discharged battery in the battery charger to recharge.
4. Ensure that the instrument has been properly cleaned according to the instructions in the chapter [Cleaning & Maintenance](#) on page 67.
5. Be aware of the following conditions that may affect ultrasound transmission and the accuracy of the exam:
  - A catheter in the patient's bladder. The presence of a catheter may affect the accuracy of the bladder volume measurement, but the measurement may still be clinically useful (detecting a blocked catheter, for example).
  - Previous suprapubic or pelvic surgery. Scar tissue, surgical incisions, sutures, and staples can affect ultrasound transmission and reflection.

Do not use the BVI 9600 on:





- Patients with ascites.
- Patients with open skin or wounds in the suprapubic region.
- Pregnant patients.



---

## PROCEDURE 2. MEASURE BLADDER VOLUME

---

1. Turn on the BVI 9600 by pressing the **Power** button. 
2. Select the exam mode.
  -  Select AortaScan® mode. (See [Measuring Abdominal Aortic Diameter.](#))
  -  Select to scan a female patient who has not had a hysterectomy.
  -  Select to scan all other patients
3. With the patient lying in a supine position and with the abdominal muscles relaxed, palpate the patient's pubic bone.



4. Place an ample quantity of ultrasound gel, with as few air bubbles as possible, midline on the patient's abdomen, approximately one inch (3 cm) above the pubic bone.
5. Stand to the right of the patient. The probe handle should point toward you.

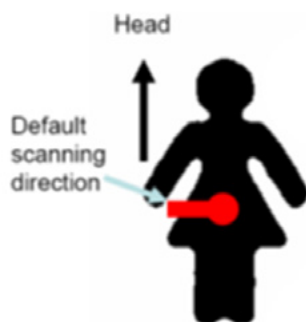

6. Place the probe on the gel and aim it toward the expected location of the bladder. For most patients, this means angling the probe slightly toward the patient's tail bone so the scan clears the pubic bone.

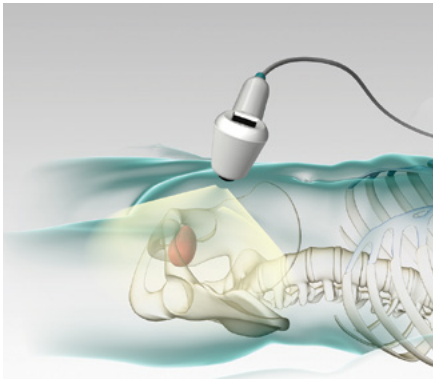

7. If you are scanning an obese patient, lift as much abdominal adipose tissue out of the way of the instrument as possible. Apply more pressure to the probe in order to reduce the amount of adipose tissue through which the ultrasound must pass.
8. Ensure that there are no air gaps between the probe and the patient's skin and that you are applying enough pressure to maintain adequate skin contact until the scan is complete.

*Note: If you apply too much pressure, the instrument will display a greater than symbol (>) preceding the measurement. Apply less pressure and re-scan the patient. The greater than symbol may also appear if the two sides of the bladder wall are outside the image cone as a result of a big/full bladder that is larger than the ultrasound scan.*

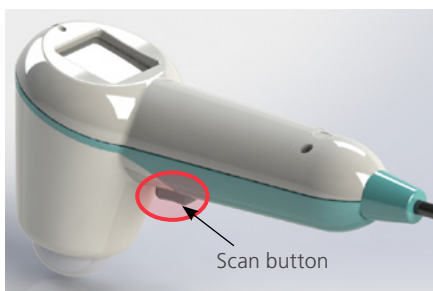

9. Press and release the **Scan** button located on the underside of the probe. Hold the probe steady while scanning; avoid changing its position, angle, or pressure.

As the scan progresses, sections of the bladder will appear on the console screen. When you hear the end-scan tone, the scan is complete.

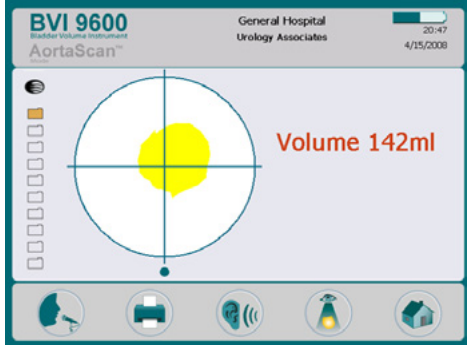
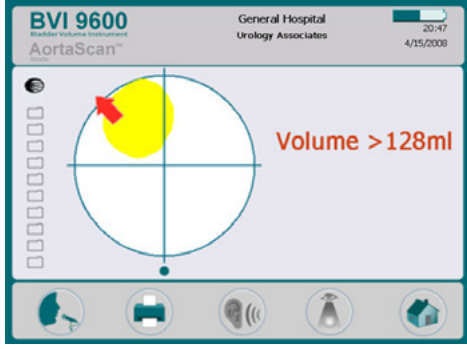

10. When the Results screen appears, assess the accuracy of the scan as follows.

Table 22. Bladder Measurement Accuracy

RESULT	INDICATOR(S)	EXAMPLE
Successful	If the scan is successful and “on target,” the probe will show eight arrows on the aiming display. On the console display, the bladder will appear in the center of the crosshairs.	
Off-target	If the scan is unsuccessful or “off-target,” the probe will show an arrow (solid or flashing) indicating the direction to move the probe to be on target. If the arrow is solid, it means you are slightly off target and it is strongly recommended you re-aim and re-scan. If the probe shows a single flashing arrow, you must re-aim and re-scan. In either case, the bladder will not be centered in the crosshairs.	
Pubic bone interference	You may also see a display indicating that the pubic bone is inside the image cone. If this occurs, you may want to re-aim and re-scan. Although the bladder may be shown as centered in the image cone, and your measurement may be complete, there is a possibility the pubic bone is obscuring part of the bladder. By re-aiming and re-scanning you can ensure you have captured the bladder fully inside the image cone.	

11. If necessary, use the following orientation in order to re-aim the probe, and then re-scan the patient:

- The small dot at the base of the crosshairs represents the feet of the patient.
- The top of the crosshairs represents the patient’s head.
- The upper left quadrant represents the patient’s right shoulder.

12. If you would like to save the exam data, continue to the next procedure.

---

## PROCEDURE 3. SAVE, REVIEW, & PRINT EXAM RESULTS

---

### IMPORTANT



In order to save the exam, you must record an annotation. If you do not record an annotation, the scan result will be lost, and the next exam you perform will overwrite the non-annotated exam.

After performing an exam, you can save the results by recording a voice annotation. Be sure to include all relevant exam information, the patient's name and the name of the person performing the exam. The annotation cannot exceed 10 seconds in length.

The instrument can store ten scans with voice annotations. If you are using the optional ScanPoint® with QuickPrint software, the exams will be automatically transferred and saved in ScanPoint when you log in. (Refer to the ScanPoint with QuickPrint user's manual for more information).

*Note: If the instrument battery runs low or the instrument goes into Sleep mode, any non-annotated exam data is lost. However, the instrument does not erase any annotated exam results when it goes into Sleep mode. To make sure you do not lose any patient data, add a voice annotation to every patient exam.*

### RECORD A VOICE ANNOTATION (OPTIONAL)

1. On the console, press and release the **Record** button .
2. Hold the probe approximately six inches (15 cm) from your mouth, and then record the patient information by speaking clearly into the probe microphone located just above the aiming display on the probe.
3. When you are finished recording, press the **Stop** button .

*Note: An hourglass icon will appear to indicate the scan is being saved.*

4. Press the **Listen** button . The voice annotation plays.

If you are not satisfied with the recording, press the **Record** button  again to record a new annotation.

*Note: You can make a new recording only if the instrument still displays the bladder volume for that particular exam.*

If desired, the instrument is ready to perform another scan.

### REVIEW OR PRINT THE EXAM (OPTIONAL)

5. In order to review the scan images, press the **Review** button .

*Note: Scans must be saved in order to be reviewed. See Step 8 for saving.*

- To print via the onboard printer, press the **Print** button .

Figure 15. Scan Printout from Onboard Printer

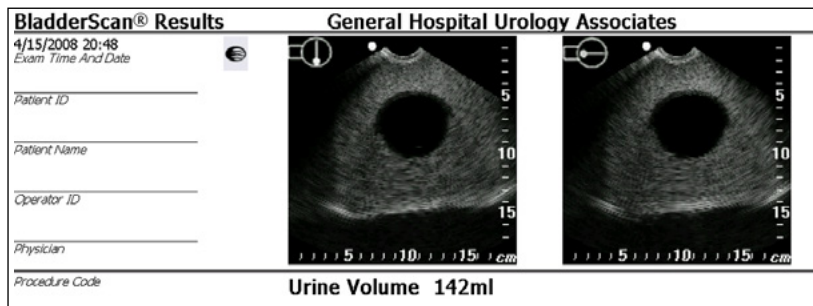

The label provides fields for patient ID, patient name, operator, and physician. This information must be written on the printout.

*Note: If the facility name, date, and time have not been set, those lines will be skipped on the printout.*

*Note: The BVI 9600 prints on thermal paper, which fades over time. For maximum storage life, Verathon® recommends you photocopy the printout.*



- If another exam on the patient is required, press the **Home** button  and repeat the procedures within this chapter.
- Once you have completed the scan, wipe the ultrasound gel off the patient and the probe.  
For complete cleaning instructions, see the [Cleaning & Maintenance](#) chapter on page 67.

---

## PROCEDURE 4. DELETE A SAVED EXAM

---

Saved exams are indicated by yellow folder icons along the left edge of the display. Complete this procedure if you would like to delete a saved exam.

- On the Home screen, press the **Review** button . The Review screen opens.
- Press the **Down Arrow** button  until the desired exam is highlighted in blue.
- Press the **Delete** button . The exam is deleted.

## MEASURING ABDOMINAL AORTIC DIAMETER



### WARNING

The BladderScan 9600 in AortaScan® mode is not a diagnostic or screening device. If clinically indicated, appropriate patients should be referred for a diagnostic standard (confirmatory) test, regardless of test results.



### WARNING

The BladderScan 9600 in AortaScan mode is designed to detect the fluid (blood) filled region of the abdominal aorta only. The AortaScan cannot detect the presence of a blood clot (thrombus) and therefore may provide a false negative result.



### WARNING

The BladderScan 9600 in AortaScan mode is an ultrasound-based device and is subject to all limitations of this method. If clinically indicated, appropriate patients should be referred for a diagnostic standard (confirmatory) test, regardless of test results.



### WARNING

**Risk of explosion.** If you use the BladderScan BVI 9600 in the presence of flammable anesthetics, the hazard of potential explosion exists.



### WARNING

**Potential patient hazard.** To date, exposure to low-power, pulsed diagnostic ultrasound has not been shown to produce adverse effects. However, medical professionals should use ultrasound only when clinically indicated, using the lowest exposure times possible to obtain appropriate measurements. The ultrasonic output of the BladderScan BVI 9600 is not user adjustable and is limited to the minimum level necessary for effective performance. For more information about the acoustic output levels of this device, see the chapter [Product Specifications](#) on page 80.



### WARNING

Do not use the BladderScan BVI 9600 on:

- A patient who has open skin or wounds in the mid-abdominal area.
- A patient with ascites.
- A pregnant patient.



## WARNING

**Risk of inaccurate measurements/results.** When using the instrument, be aware of the following conditions that can decrease the accuracy of exam results.

- In some cases, the normal operating tolerances of the instrument can cause it to report a falsely normal or abnormal measurement in AortaScan® Mode. For more information, see [Interpret the Aortic Measurement Results](#) on page 61.
- Visual verification that the aorta position is fully within the scan cone on the displayed images is important while in the AortaScan Mode.
- A thrombus (blood clot) can complicate aortic measurements. A soft, blood-like thrombus may appear as part of the lumen. However, a calcified thrombus may appear as part of the aorta's wall, resulting in a measurement of lumen diameter that is smaller than the aorta diameter. Accordingly, in patients where thrombus is known or suspected, other imaging methods should be used prior to ruling out an aneurysm.
- Use care when scanning patients who have had previous abdominal surgery. Scar tissue, surgical incisions, sutures, and staples can affect ultrasound transmission and accuracy.
- Ensure that the patient fasts for 12 hours prior to undergoing an aortic diameter measurement in order to minimize the presence of bowel gas, which may obstruct proper measurement.
- Obesity may affect ultrasound aortic diameter measurements. For more information, see [Obesity](#) on page 64.

Accuracy is compromised if the user does not obtain an optimal, repeatable image.

The BladderScan BVI 9600 provides the capability to measure abdominal aortic diameter noninvasively using 3D ultrasound. AortaScan ultrasound may be preferred as the initial imaging modality for measuring abdominal aortic diameter due to its portability, availability, lack of ionizing radiation, and cost when compared to other alternatives like CT, CTA, MRI, MRA, or standard ultrasound performed by trained sonographers.

The BladderScan BVI 9600 can measure aortic diameters ranging between 3.0 and 12.4 cm with a diameter accuracy of  $\pm$  (15% + 0.5 cm). For details about the normal variability of scan results, and the effect of that variability on potential rupture risk, refer to Table 23 on page 61.

*Note: The BladderScan BVI 9600 is not intended for screening or diagnosis of abdominal aortic aneurysms (AAAs), or for use on acute events such as aortic dissection, ulcer, or rupture.*

In B-mode report type, the scan output provides two images: an aiming display on the left and a results image on the right. The BVI 9600 also displays the calculated diameter of the aorta in centimeters (cm) below the aiming display.

Figure 16. B-Mode Report Type

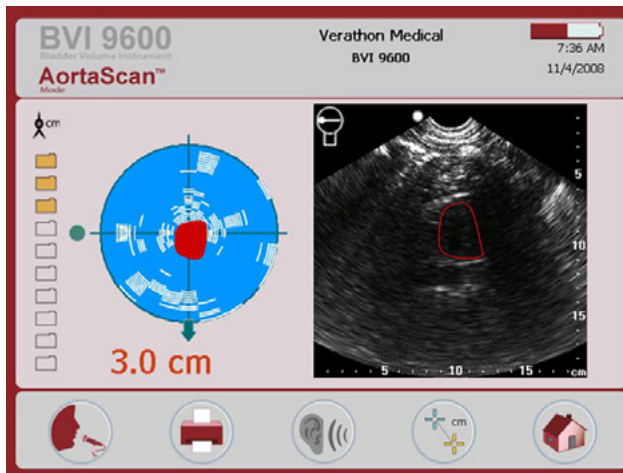
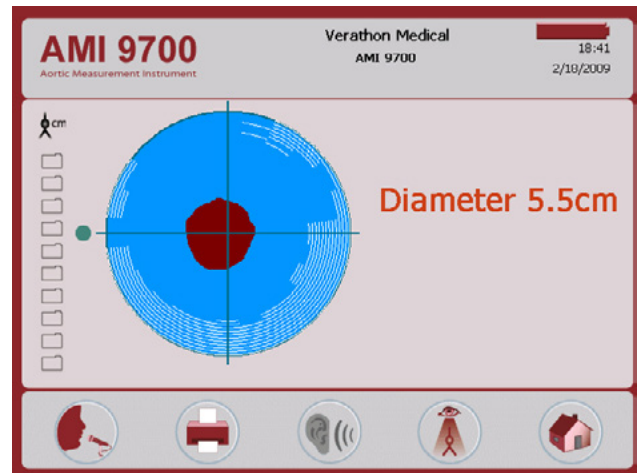

Figure 17. G-Mode Report Type



### AIMING DISPLAY

The aiming display illustrates the location of the aorta relative to the ultrasound probe. The center of the two axes represents the center of the probe. The aorta is shown in red. The white lines represent areas of high reflection, most likely caused by bowel gas.

When aiming, the goal is to angle the probe so the aorta in red is not intersecting any white lines (bowel gas) on the aiming display. Arrows will appear, which indicate the direction the probe needs to move in order to produce a better scan.

### RESULTS DISPLAY

The Results display provides an image of the cross section of the abdominal space below the probe. Both axes of the image are in centimeters. The abdominal aorta is seen as a dark circular shadow with a red outline amidst the black and white "speckling" of the ultrasound image.



---

## PROCEDURE 1. PREPARE FOR THE EXAM

---

1. Make sure you are familiar with the parts of the instrument (see [Introduction](#)).
2. Check the instrument battery icon to ensure the battery has sufficient power.

*Note: If the battery icon is 1/4 full or less, replace the battery with a freshly charged battery before proceeding. Ensure the instrument is off before you replace the battery. Place the discharged battery in the battery charger to recharge.*

3. Ensure that the instrument has been properly cleaned according to the instructions in the chapter [Cleaning & Maintenance](#) on page 67.
4. Be aware of the following conditions that may affect ultrasound transmission and the accuracy of the exam:
  - Bowel gas is a common problem for abdominal ultrasound measurement and results in unreadable exams. To avoid bowel gas obstruction of the ultrasound, have patients fast for 12 hours prior to the exam. When aiming, position the probe so that the image of the aorta on the aiming display does not intersect with bowel gas.
  - Previous abdominal surgery. Scar tissue, surgical incisions, sutures, and staples can affect ultrasound transmission and reflection.

Do not use the BVI 9600 on:

- Patients with ascites.
- Patients with open skin or wounds in the suprapubic region.
- Pregnant patients.

---

## PROCEDURE 2. MEASURE ABDOMINAL AORTIC DIAMETER

---

1. Turn on the instrument by pressing the **Power** button .
2. With the patient in the supine position, identify four equally spaced scan locations between the xiphoid process and the umbilicus.

Figure 18. Four Scan Locations for Measuring



3. Place an ample amount of ultrasound gel on the patient's abdomen in the selected scan locations.
4. Standing at the patient's right side, place the probe on the gel at the first position.
5. Hold the probe with the long axis aligned with the midline of the abdomen. Do not hold the probe with the handle pointing to either side of the patient.

Figure 19. Correct and Incorrect Orientation of the Probe

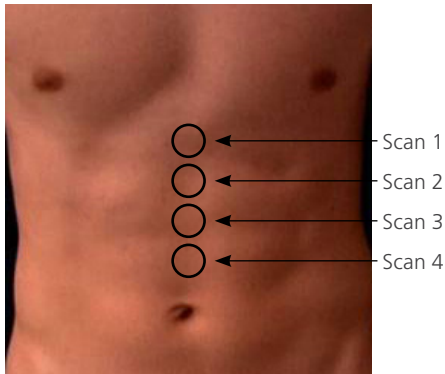
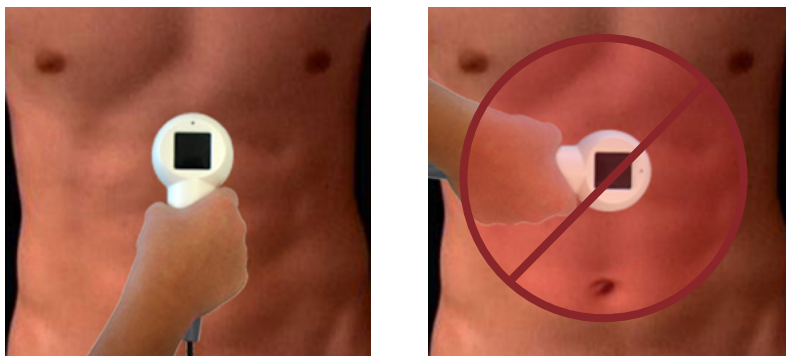

6. Press and release the **Scan** button on the underside of the probe. When you hear the tone, the scan is complete.

*Note: Do not move the probe while the scan is in progress as that will decrease the accuracy of the measurement.*

7. Save the exam results by creating a voice annotation. For more information, see [Save, Review, & Print Exam Results](#) on page 65.

8. Perform three more measurements and save and annotate the result of each exam.

Figure 20. Results Screen

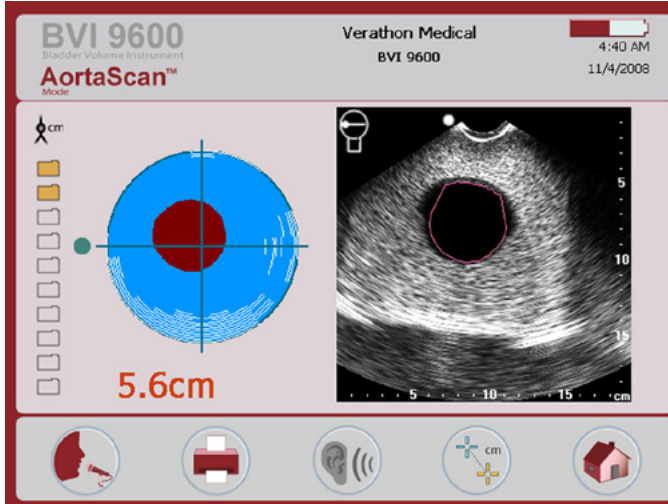





9. If another exam on the patient is required, press the Home button  and repeat this procedure.  
If you would like to measure abdominal aortic diameter manually, complete the procedure [Measure Aortic Diameter Manually \(Optional\)](#) on page 60.
10. Once you have completed the exam, wipe the gel off the patient and probe.  
For ScanPoint® subscribers, logging onto ScanPoint automatically transfers and saves your annotated exams to your ScanPoint host computer.

### PROCEDURE 3. MEASURE AORTIC DIAMETER MANUALLY (OPTIONAL)

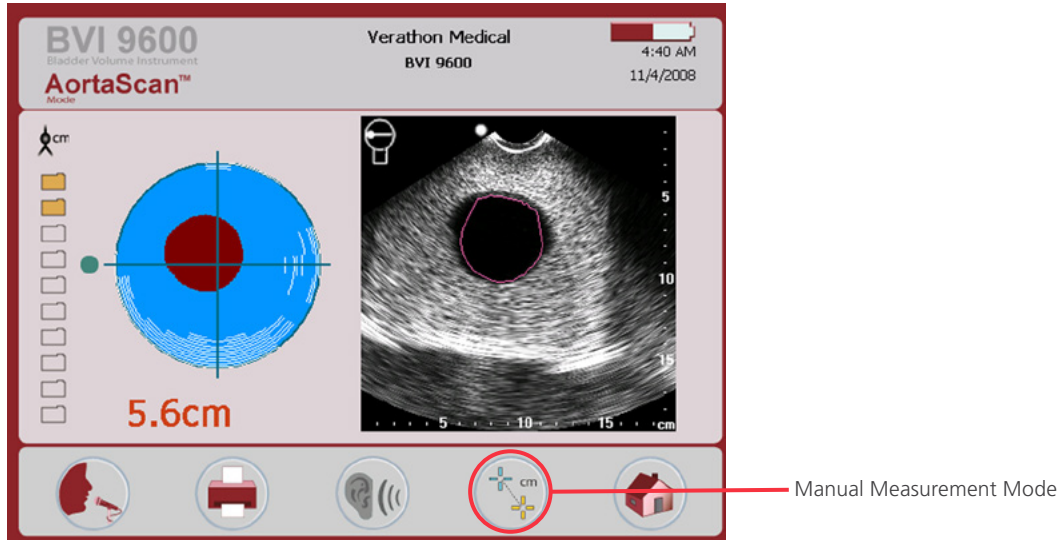
To measure abdominal aortic diameter manually, you must perform a scan in B-mode. For information about setting the instrument in B-mode, see [General Preferences Screen](#) on page 28.

1. After completing the scan, press the **Manual Mode** button .



2. By using the following button controls, move one cursor to the right edge of the aorta and move the other cursor to the opposite edge of the aorta:
  - Press the **Axis Select** button  to swap between the Up and Down arrows or the Left and Right arrows.
  - Use the **Manual Mode** button  in order to swap between cursors on the results display.
  - When you are finished moving the cursors, press the **Return** button .

This records the measurement and exits Manual Measurement Mode. The manual measurement is displayed on the Review screen. Record a voice annotation in order to save the manual measurement result.

## PROCEDURE 4. INTERPRET THE AORTIC MEASUREMENT RESULTS



### WARNING

The BladderScan 9600 in AortaScan® mode is not a diagnostic or screening device. If clinically indicated, appropriate patients should be referred for a diagnostic standard (confirmatory) test, regardless of test results.



### WARNING

The BladderScan 9600 in AortaScan mode is designed to detect the fluid (blood) filled region of the abdominal aorta only. The AortaScan cannot detect the presence of a blood clot (thrombus) and therefore may provide a false negative result.



### WARNING

The BladderScan 9600 in AortaScan mode is an ultrasound-based device and is subject to all limitations of this method. If clinically indicated, appropriate patients should be referred for a diagnostic standard (confirmatory) test, regardless of test results.

The BladderScan BVI 9600 in AortaScan mode can measure diameters ranging between 3 and 12.4 cm with a diameter accuracy of  $\pm (15\% + 0.5 \text{ cm})$ . This error-range data (Table 23) indicates a range of values obtained by the device relative to follow up and clinical significance, specifically with respect to risk vs. diameter.

Table 23. Expected Aortic Measurement Ranges

ACTUAL AORTIC DIAMETER												
	3.0 cm		3.5 cm		4.0 cm		4.1 cm		5.0 cm		5.3 cm	
Average estimated risk of rupture for actual aortic diameter	0%		0%		0%		1%		11%		11%	
Aortic diameter as reported by the device based on allowable tolerances												
	Min	Max	Min	Max	Min	Max	Min	Max	Min	Max	Min	Max
$\pm 15\%$	2.55	3.45	2.98	4.03	3.40	4.60	3.49	4.72	4.25	5.75	4.51	6.10
With additional $\pm 0.5 \text{ cm}$	2.05	3.95	2.48	4.53	2.90	5.10	2.99	5.22	3.75	6.25	4.01	6.60
Average estimated risk of rupture for reported aortic diameter	0%	0%	0%	1%	0%	1%	0%	11%	0%	26%	0.5–5.0%	26%

An unobstructed scan has been achieved when the probe displays eight solid green arrows.



When the scan is complete, the BladderScan BVI 9600 shows the aortic diameter and two displays on the console screen.

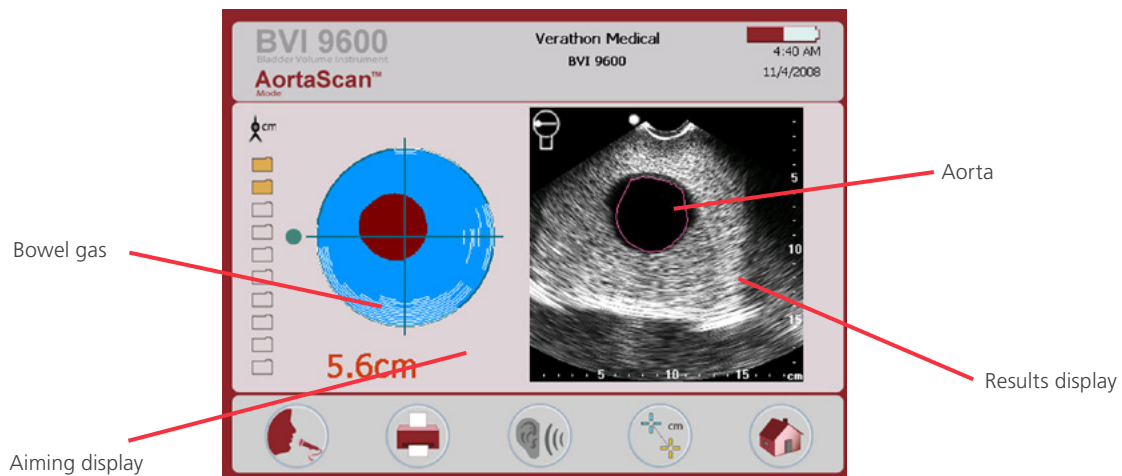

The aiming display on the left side of the screen shows the location of the aorta relative to the probe, as viewed looking from the probe into the body. The aorta is shown in red and bowel gas is shown as white lines. The green dot on the left side is the reference mark correlating the aiming display with the results display on the right side of the screen.

The results display is a cross-section of the abdomen below the probe. The abdominal aorta is shown as a dark circular shadow with a red outline. The white dot on the image is a reference mark correlating the results display with the aiming display.

## MEASURING AORTIC DIAMETERS < 3 CM

The BladderScan BVI 9600 can detect aortas with diameters between 3 cm and 12.4 cm. Diameters less than 3 cm occur in patients who have normal-sized aortas.

The round shadow at 6 cm depth in the results display is the patient's abdominal aorta. Patients with aortas less than 3 cm in diameter will show no red outline around the aorta in the results display, as the diameter cannot be measured automatically. However, because of the potential variability between actual and measured diameters, the absence of a red outline around the aorta cannot be relied upon to identify an abdominal aorta less than 3 cm in diameter. The diameter can also be estimated using Manual Measurement Mode.

The "speckled" look to the Results display indicates the ultrasound signal was not blocked by bowel gas. The clearly visible aorta and the lack of any arrows telling the user to re-aim the probe mean the user can feel confident that the lack of diameter information is due to a small aorta and not due to the presence of bowel gas. In this case, the aortic diameter measurement is valid.

## PARTIAL GAS OBSTRUCTION

In some cases, gas or air bubbles may be present but do not block the aorta entirely. In that case, diameter measurements are still calculated, but they are not typical.

A green arrow on the console and a solid green arrow on the probe indicate the abdominal aorta can be detected, but the presence of bowel gas prevents a proper measurement.

Figure 21. Partial Gas Obstruction

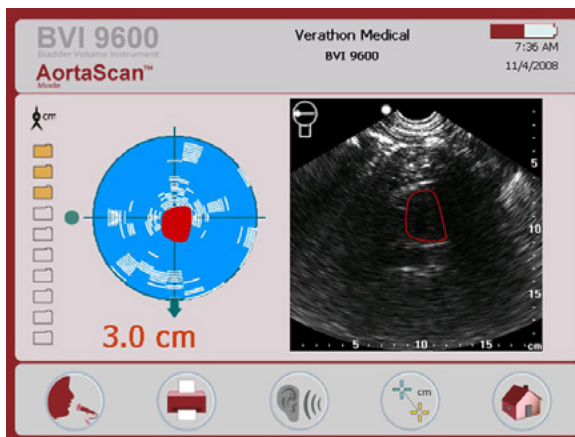

Moving the probe 1/2 to 1 inch (1 to 3 cm) in the direction of the arrow has a high probability of obtaining a successful scan.

In this case, the probe should be repositioned and the patient rescanned. Gently but firmly work the probe into the tissues of the abdomen with a side-to-side rocking motion to try and displace any bowel gas obscuring the aorta. Do not move the probe while the scan is in progress as that will decrease the accuracy of the measurement.

## SUBSTANTIAL GAS OBSTRUCTION

A substantial amount of gas in the abdomen can block ultrasound from reaching the aorta and results in an unreadable or improper scan.

A red arrow on the console and a flashing green arrow on the probe indicate bowel gas has substantially obscured the aorta. No diameter measurement can be calculated and the results display shows a diameter of < 3 cm, meaning the aorta was not detected.

Figure 22. Substantial Gas Obstruction

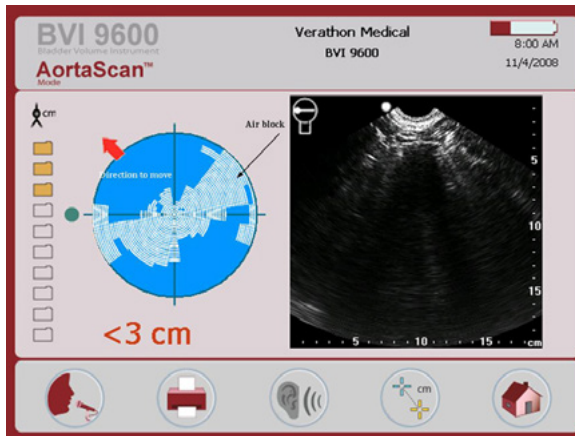

Although moving the probe 1/2 to 1 inch (1 to 3 cm) in the direction of the arrow has a low probability of providing a successful scan, an additional scan should be attempted. In this case, the probe should be repositioned and the patient rescanned. Gently but firmly work the probe into the tissues of the abdomen with a side-to-side rocking motion to try and displace any bowel gas obscuring the aorta.

If rescanning is not successful, the exam should be postponed and rescheduled. Have the patient fast for 12 hours prior to the exam.

## OBESITY

Attenuation of the ultrasound signal by excess abdominal fat can result in a poor ultrasound image, which affects the quality of the diameter measurement.

With obese patients, try pressing the probe firmly into the abdomen to reduce the distance to the aorta as much as possible, while attempting to minimize patient discomfort.

In rare cases, it is possible for a patient's abdomen to be too thick for the ultrasound to reach the aorta. If a patient has an extra-thick abdomen where the distance from the probe face to the aorta is greater than 18 cm (7 in), the BVI 9600 will not detect the aorta appropriately. In these cases, alternative imaging methods should be used.



---

## PROCEDURE 5. SAVE, REVIEW, & PRINT EXAM RESULTS



---

### SAVE/ANNOTATE AN EXAM (OPTIONAL)

#### IMPORTANT

In order to save the scan, you must record an annotation. If you do not record an annotation, the scan result will be lost, and the next scan you perform will overwrite the non-annotated scan.

To save a scan, you must create a voice annotation. The BVI 9600 does not automatically save each scan. It is recommended that you add a voice annotation or write down the diameter calculated for each location.

1. On the console, press the **Record** button .
2. Hold the probe approximately six inches (15 cm) from your mouth, and then record the patient information by speaking clearly into the probe microphone located just above the aiming display on the probe.
3. When you are finished recording, press the **Stop** button . An hourglass icon appears to indicate that the scan is being saved.
4. Press the **Listen** button . The voice annotation plays.

If you are not satisfied with the voice annotation, repeat Step 1 through Step 3.

*Note: You can make a new recording only if the instrument still displays the aortic diameter for that particular scan.*

If desired, the instrument is ready to perform another scan.

### REVIEW AN EXAM (OPTIONAL)



5. Press the **Review** button  on the console.

On the Review Screen, two types of diameter measurements may be displayed:

- Diameter<sub>V-MODE</sub> – Diameter measured automatically by BVI 9600.
- Diameter<sub>Manual</sub> – Diameter measured manually in Manual Measurement Mode. See [Measure Aortic Diameter Manually \(Optional\)](#) for further details.

*Note: You must record a voice annotation in order to review the results.*

### PRINT AN EXAM (OPTIONAL)



6. If you are printing exam results immediately after the measurement is taken, on the Results screen, press the **Print** button .
7. If you are printing saved exam results, press the **Review** button , select the saved exam, then press the **Print** button .

---

## PROCEDURE 6. DELETE A SAVED EXAM

---

Saved exams are indicated by yellow folder icons along the left edge of the display. Complete this procedure if you would like to delete a saved exam.

1. On the Home screen, press the **Review** button . The Review screen opens.
2. Press the **Down Arrow** button  until the desired exam is highlighted in blue.
3. Press the **Delete** button . The exam is deleted.

# CLEANING & MAINTENANCE

---

Routine cleaning and maintenance will help ensure safe and effective operation of the BladderScan BVI 9600. For more information, please contact your authorized BladderScan Service Center, your local BladderScan distributor, or Verathon® Customer Care.

## CLEANING & DISINFECTING

Clean and disinfect the instrument before use and between patient exams.



### WARNING

This product may only be cleaned and disinfected by using the approved processes provided in this manual. Cleaning and disinfection methods listed are recommended by Verathon based on compatibility with component materials.



### WARNING

Availability of cleaning and disinfection products varies by country, and Verathon is unable to test products in every market. For more information, please contact Verathon Customer Care at 1.800.331.2313 or your local representative. For additional contact information, visit [verathon.com/contact-us](http://verathon.com/contact-us).



### WARNING

Ensure that you follow the manufacturer's instructions for handling and disposing of the cleaning and disinfection solutions provided in this manual.

---

## PROCEDURE 1. CLEAN THE INSTRUMENT

---



### WARNING

Cleaning is critical to ensuring the component is ready for disinfection. Failure to properly clean the device could result in a contaminated instrument after completing the disinfection procedure.

*Cleaning* is the removal of all visible soil or contaminants from the exterior surfaces of the device. The device must be cleaned after every use, and cleaning is an essential step before disinfection.

1. Wipe the ultrasound gel completely off the probe.
2. Use a moistened, soft cloth to remove particulate matter or body fluids that remain on the instrument.
3. Do not re-use cloths or wipes.
4. Allow the device to air dry, or towel dry with a clean dry cloth. Next, you must disinfect the instrument.

## PROCEDURE 2. DISINFECT THE INSTRUMENT

### IMPORTANT

Failure to heed the following may cause device damage not covered by the warranty:

- Do not immerse the instrument in the disinfectant solution.
- Do not subject any part of the instrument to steam, ethylene oxide, radiation, or similar methods of sterilization or autoclaving.
- Do not use CidexPlus® to disinfect the instrument. CidexPlus will damage the plastic enclosure.

Disinfectants and cleaning methods listed are based on compatibility with product materials, not biological effectiveness. Refer to the instructions from the manufacturer of the disinfectant for guidance on biological effectiveness of the disinfectant.

The following liquid disinfectants and wipes are compatible with the materials used in the instrument:

- A-456® II Disinfectant
- Accel® TB Wipes
- Cavicide®
- CaviWipes®
- Chloro-Sol Spray®
- Clorox® Germicidal Wipes
- Sani-Cloth® Bleach Wipes
- Sani-Cloth® Germicidal Wipes
- Sani-Cloth® Plus Germicidal Wipes
- Sporidicin® Disinfecting Towelettes
- T-Spray II®

The level of disinfection required for a device is based on the type of tissue it contacts during use. Based on the intended use of the BladderScan BVI 9600, low-level disinfection is the minimum level required.

1. Ensure the instrument has been properly cleaned according to the procedure [Clean the Instrument](#) on page 67.
2. Ensure the disinfectant has not expired.
3. If using a liquid disinfectant, prepare the disinfection solution according to the manufacturer's label instructions, ensuring that you are using the proper concentration.
4. Apply the solution to a soft cloth or wipe.

*Note: Do not spray or apply liquid disinfectants directly to the surface of the device, and do not soak the device in liquids.*

5. Wipe the surfaces of the device and allow the surface to remain wet for the required contact duration. Follow the manufacturer's instructions for the appropriate disinfection level contact duration.
6. Do not re-use cloths or wipes.
7. If rinsing or removal of the disinfectant solution from the device is required by the disinfectant manufacturer's instructions, wipe with a clean soft cloth dampened in sterile water. Verathon® recommends wiping the device three separate times to remove all residual disinfectant.
8. Allow the device to air dry, or towel dry the device with a clean, dry cloth.

## REGULAR INSPECTIONS

Verathon® recommends that the BVI 9600 be certified by an authorized BladderScan Service Center once a year. Certification service includes comprehensive inspection and testing of the instrument to ensure accurate performance in clinical use. For more information, please contact your authorized BladderScan Service Center, your local BladderScan distributor, or Verathon Customer Care.

*Note: ScanPoint® Online customers can maintain device certification via the Internet by accessing their ScanPoint account. For more information about using ScanPoint Online, please refer to the ScanPoint with QuickPrint Operations and Maintenance Manual or contact your Verathon representative.*





### WEEKLY INSPECTIONS

Once a week, you should inspect the probe and cable for physical faults or cracks. Cracks that allow the ingress of fluid may affect the performance of the instrument. Any apparent cracks or faults in the console, probe, or the cable that links the console and the probe must be referred to your authorized BladderScan Service Center, your local BladderScan distributor, your local Verathon representative, or Verathon Customer Care.

## MAINTENANCE



### PROCEDURE 1. RUN A SELF TEST

The BVI 9600 can perform a number of self-diagnostic tests. To access the Self Test utility:

1. From the Home screen, press the **Settings** button .
2. When the Settings screen opens, press the **Up Arrow** button  or **Down Arrow** button  buttons until **Self Test** is highlighted in red, then press the **Enter** button . The Self Test screen opens and testing begins automatically. The display provides status and results, and when the test is complete, the printer prints the results.

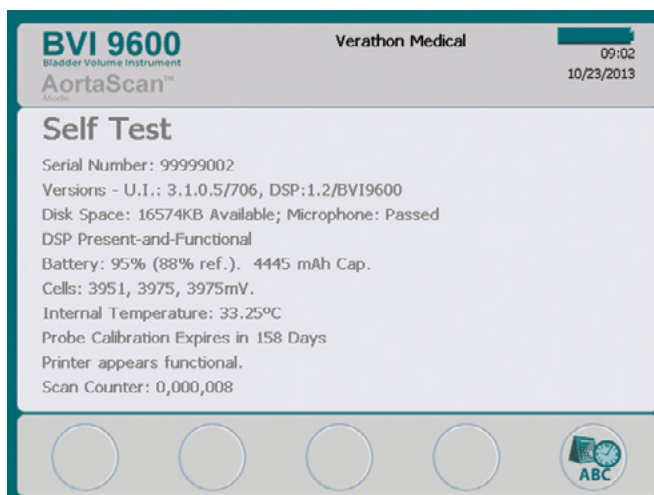
*Note: Make sure the printer is loaded with paper. See [Load the Thermal Paper](#).*



3. If the screen indicates any failed tests or abnormal results, contact your authorized BladderScan representative, or contact the Verathon Customer Care Department.
4. When the test is complete, press the **Settings** button  to return to the Settings screen, then press the **Home** button  to return to the Home screen.

## PROCEDURE 2. UPDATE THE SOFTWARE

1. On the instrument, on the Home screen, press the ScanPoint button .
2. On the computer, double-click the ScanPoint with QuickPrint icon. ScanPoint opens.



3. On the computer, in the ScanPoint QuickPrint window, click **Find New**. QuickPrint establishes a connection with the instrument, and an icon for the device appears in the left pane.

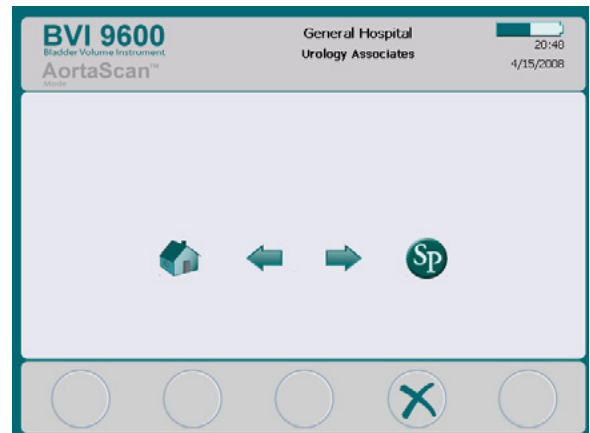
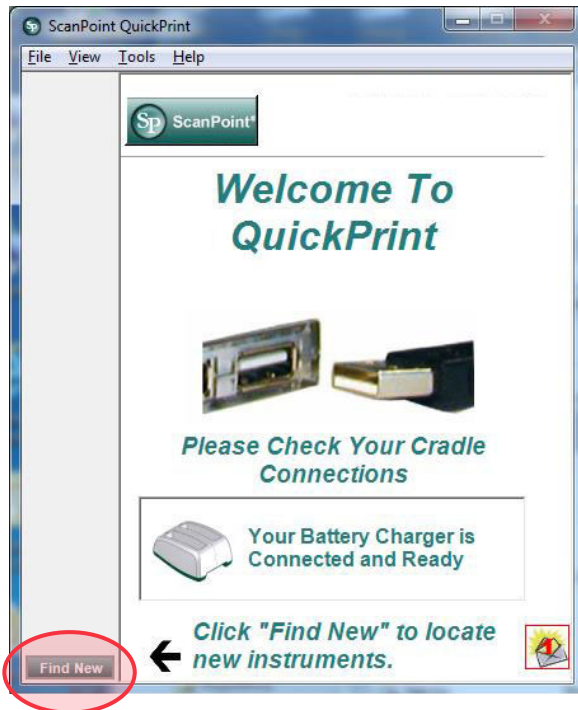

4. Select the 9000 Series device, verify that the serial number matches the device you are updating, and then click the **Update Instrument** button.

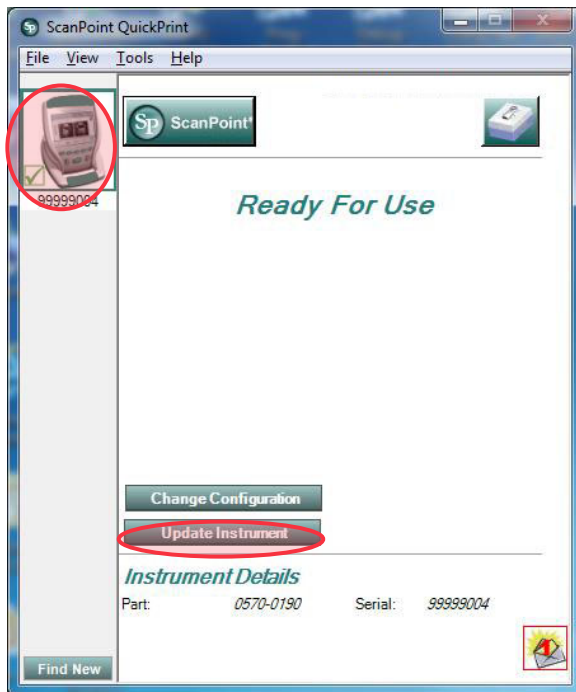

5. If any updates are available, the device downloads and installs them. The console displays a progress bar and automatically restarts when the installation is complete.  
If no updates are available, nothing happens.
6. If you would like to view the current software version and verify that the newest software is installed, complete the procedure [Run a Self Test](#). The results screen displays the software version.

### PROCEDURE 3. CALIBRATE THE PROBE USING THE SCANPOINT SYSTEM

If you do not have ScanPoint® with QuickPrint software, you must send your instrument to an authorized Verathon® service center for calibration. Contact Verathon Customer Care for more information.

At minimum, the BVI 9600 must be calibrated every 12 months in order to ensure accurate results. Calibrating ensures accurate and proper alignment of the instrument's internal coordinate system. If calibration is not performed by the prescribed date, the instrument can still be used to take scans but measurements may be compromised. When calibration is required, a warning appears in the display header.

Figure 23. Calibration Warning

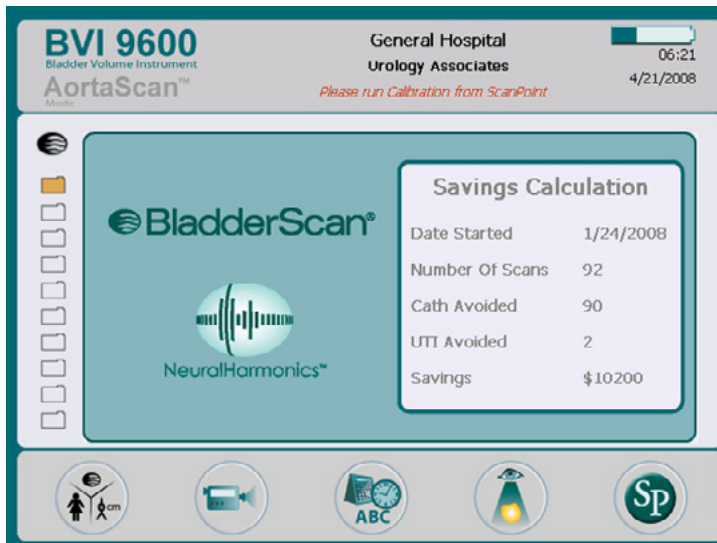

1. Within 10 feet of the Battery Charger/Wireless Hub, place the calibration tank on a flat, nonreflective surface, and then remove the lid.
2. Pour clean, room-temperature water into the container, filling to the indicator mark. Ensure that there is a minimal amount of bubbles in the water.
3. Using the notches to position the spiral-shaped target correctly, place the target in the container.

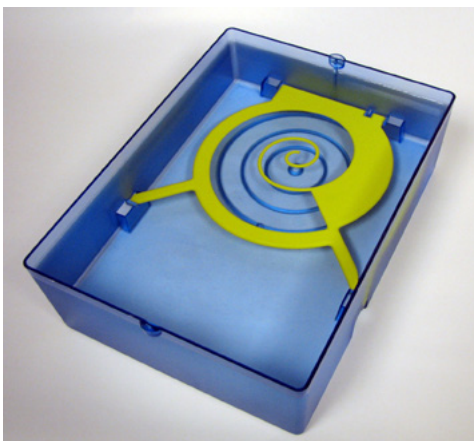

4. Replace the lid onto the calibration container.



5. Place the probe into the cutout in the lid. Ensure that the tip of the probe is submerged in the water.



6. On the computer, double-click the ScanPoint with QuickPrint icon. ScanPoint opens.



7. On the console, on the Home screen, press the **ScanPoint** button .
8. On the computer, in the ScanPoint QuickPrint window, click **Find New**. QuickPrint establishes a connection with the instrument, and an icon for the device appears in the left pane. On the console, two arrows appear, confirming that the console is connected to ScanPoint.

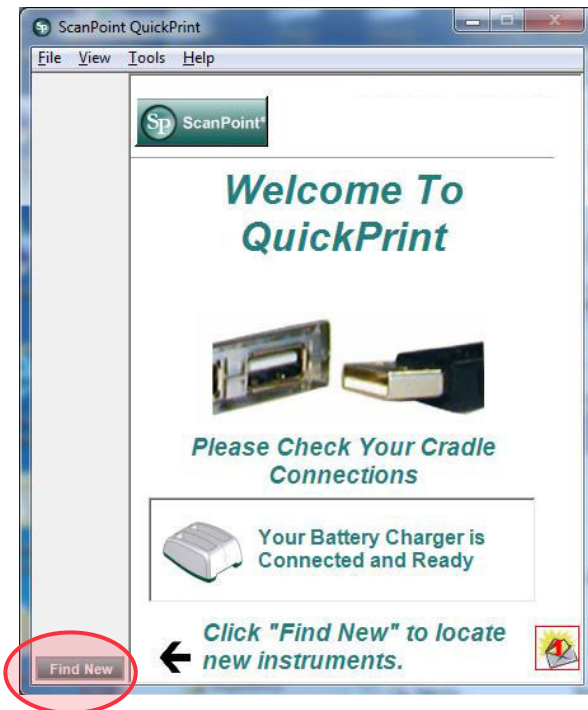

9. Select the 9000 Series device, verify that the serial number matches the device you are calibrating, and then click the calibration tank icon.

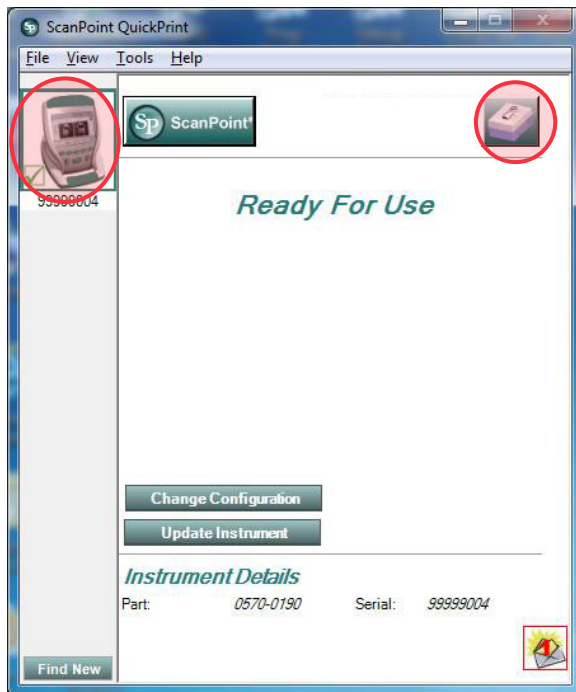

10. Click the **Calibrate** button. ScanPoint begins to scan and analyze the data in order to ensure that it meets the calibration parameters. If necessary, the instrument automatically rescans the phantom.

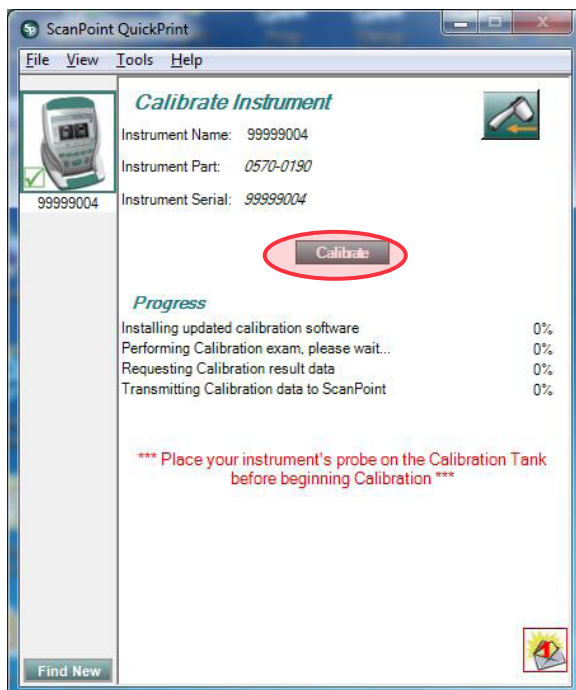

11. If calibration is successful, a "Calibration Successful" message is displayed on the computer.

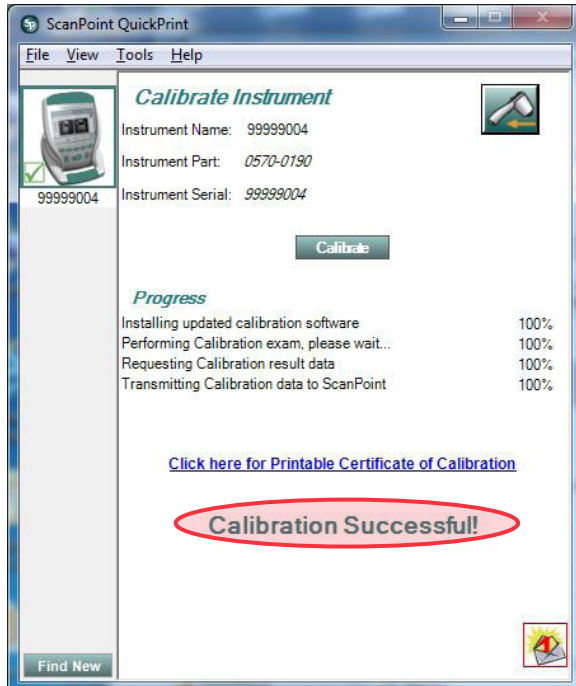

If calibration fails, a Calibration Failure message appears. Ensure that the calibration chamber has sufficient water and that the probe is seated properly in the calibration lid, and then on the Calibration Failure message, click **Yes**. ScanPoint restarts the calibration.

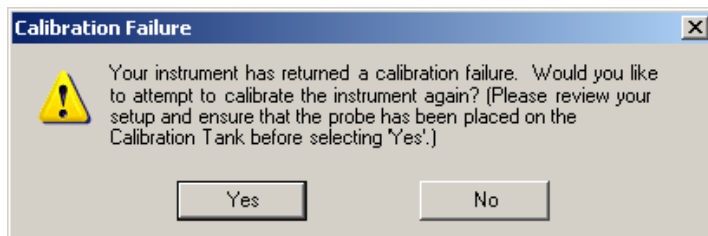

12. On the console, click the **Exit** button . This terminates the calibration procedure and ends communication with ScanPoint QuickPrint.
13. Remove the probe from the calibration lid, and then dry it with a clean, soft cloth.

## DEVICE DISPOSAL

The BladderScan BVI 9600 and related devices may contain lead, mineral oils, batteries, and other environmentally hazardous materials. When the BladderScan BVI 9600 has reached the end of its useful service life, return the device, battery charger/wireless hub, and related accessories to a Verathon® Service Center for proper disposal. Alternatively, follow your local protocols for hazardous waste disposal.

# TROUBLESHOOTING

---

## HELP RESOURCES

Verathon® provides an extensive array of customer service resources, described in the table below.

RESOURCE	DESCRIPTION
In-service CD or USB	The CD or USB flash drive included with your system that provides instructions for using the instrument.
Onboard training modules	Training modules installed on the instrument. You can refer to these modules by pressing the <b>Tutorial</b> button  at the Home screen.
Phone support	Please refer to the list of Customer Care resources available at <a href="https://verathon.com/contact-us">verathon.com/contact-us</a> .

## DEVICE REPAIR

The BladderScan BVI 9600, probe, and battery charger/wireless hub are completely sealed. There are no user-serviceable components. Verathon does not make available any type of circuit diagrams, component parts lists, descriptions, or other information that would be required for repairing the device and related accessories.

Premium warranty customers have access to a loaner unit and free shipping options that vary according to the service plan.

If you have any questions, contact your local Verathon representative or Verathon Customer Care.

# TROUBLESHOOTING PROCEDURES

## PROCEDURE 1. TROUBLESHOOT SCANPOINT CONNECTION

Complete this procedure if the console cannot connect to ScanPoint.

1. In ScanPoint, retry the connection by clicking the **Find New** button. Repeat this step up to 3 times.

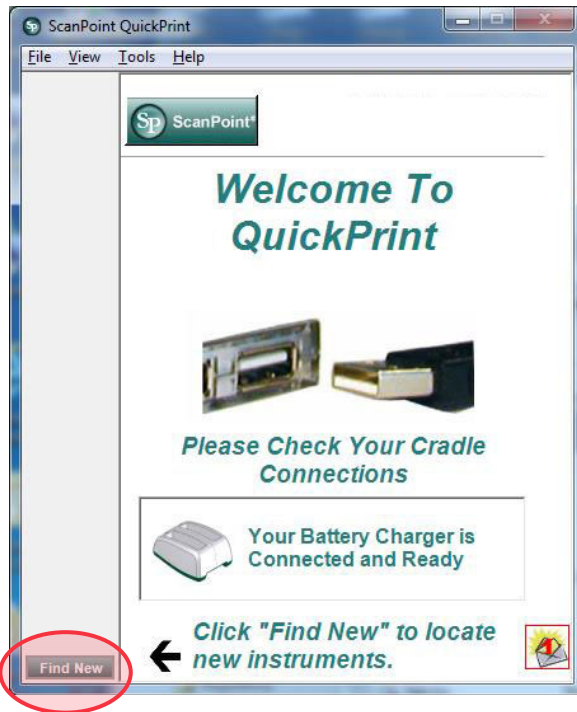

If the console does not connect, continue to the next step.

2. Turn the console off, turn the console on, and then press the **ScanPoint** button . On the PC, in ScanPoint, click **Find New**.

If the console does not connect, continue to the next step.

3. On the PC, click **Find New**. While the device is attempting to connect to ScanPoint, remove the battery.
4. Reinsert the battery, allow the device to power on, and then press the **ScanPoint** button .
5. On the PC, click **Find New**.

If the console does not connect, contact Verathon® Customer Care.

---

## PROCEDURE 2. TROUBLESHOOT POWER ISSUES

---

If the instrument does not turn on, this is usually due to a dead or discharged battery and can be remedied by exchanging the dead battery with a charged battery.

When the battery charge is too low to allow normal operation (but not too low to permit operation of the internal circuitry) the device displays the following message:

*Battery charge level is too low for instrument operation. Recharge before next use.*

In this case, the battery must be recharged or exchanged with a charged one.

You may find that you need to exchange the battery more often over time due to normal loss of battery capacity. For this reason, Verathon® recommends replacing the existing batteries with new batteries every two years.

If the instrument has stopped responding even with a new battery, perform a full reset by removing and reinserting the battery. If the instrument still does not respond, contact Verathon Customer Care.

---

## PROCEDURE 3. TROUBLESHOOT OVERHEATING INSTRUMENT

---

The BVI 9600 displays the message “Too hot” if the print head overheats.

1. Turn off the BVI 9600 immediately.
2. Ensure that the printer does not have a paper jam. If there is a paper jam in the printer, complete the following procedure, [Clear a Paper Jam](#).
3. If the instrument continues to overheat, contact Verathon Customer Care.

---

## PROCEDURE 4. CLEAR A PAPER JAM

---

Complete this procedure if the paper will not advance through the printer.

1. Open the printer door on the back of the console and clear the paper jam.
2. Ensure that the thermal paper is loaded correctly according to the instructions in the procedure [Load the Thermal Paper](#) on page 43.

# WARRANTY

---

Verathon® warrants the BladderScan BVI 9600 against defects in material and workmanship as long as it is covered by the Premium Warranty.

Verathon's policy is to honor product warranties and to perform services only on products purchased from an authorized Verathon entity. If you purchase a Verathon product or system components from unauthorized entities or if the original factory serial number has been removed, defaced, altered, or if the product is past its expiration date, your Verathon warranty will be invalidated. Purchasing Verathon products from unauthorized entities could result in receipt of products or system components that are counterfeit, used, expired, defective, or not intended for use in your region.

Pursuant to this warranty, a service center authorized by Verathon will repair or replace units that prove to be defective during the warranty period.

This warranty does not apply if the unit was misused or modified by anyone other than a service center authorized by Verathon.

The unit must be used in accordance with the instructions contained in this manual. Consumable items are not covered in this warranty and should be used in conformance with Verathon product specifications.

For further details, consult your Premium Warranty. Warranty conditions may differ outside the US. Contact your local distributor for warranty terms.

## DISCLAIMER OF ADDITIONAL WARRANTIES

There are no understandings, agreements, representations of warranties expressed or implied (including warranties of merchantability or fitness for a particular purpose) other than those set forth in the preceding Warranty section. The contents of this manual do not constitute a warranty.

Certain regional authorities disallow certain limitations on applied or implied warranties. The purchaser, user, and patient should consult applicable law if there is a question regarding this disclaimer. This information, descriptions, recommendations, and safety notations in this manual are based upon Verathon experience and judgment with BladderScan instruments as of November 2013. The contents of this manual should not be considered to be all-inclusive, or to cover all contingencies.

The physician who directs the use of the BladderScan BVI 9600 at the institution where it is in use is responsible for keeping current with clinical research in bladder volume measurements.

Please direct any questions or problems concerning bladder volume measurement, using the instrument, or the interpretation of data to the responsible physician.

# PRODUCT SPECIFICATIONS

## COMPONENT SPECIFICATIONS

### CONSOLE & PROBE SPECIFICATIONS

Table 24. General Specifications

ITEM	SPECIFICATION
Input	Lithium-ion battery.
Output	No load to full load at rated voltage. Refer to unit label.
Insulation	The power supply is Class I with basic insulation to each terminal.
Transient overvoltage	Category II
Weight	2.36 kg (5.2 lbs), with battery
Display	13.36 x 10.13 cm (5.26 x 3.99 in) (640 x 480 pixels, 120 dpi)
Integrated printer	Thermal printer

Table 25. Ultrasound Acoustic Output Parameters

Values in this table are the maximum readings obtained from three test results.

ACOUSTIC OUTPUT			MI	$I_{SPTA.3}$ (mW/cm <sup>2</sup> )	$I_{SPPA.3}$ (W/cm <sup>2</sup> )	
Global Maximum Value			0.519*	0.632	9.35	
Associated Acoustic Parameter	$p_{r.3}$	(MPa)	0.684			
	$W_0$	(mW)		1.55	1.44	
	$f_c$	(MHz)	1.74	1.74, 2.63 <sup>†</sup>	1.74	
	$Z_{sp}$	(cm)	1.90		1.90	
	Beam dimensions	$x_{-6}$ (cm)				0.321
		$y_{-6}$ (cm)				0.334
	PD	( $\mu$ sec)	2.93		2.93	
	PRF	(Hz)	400		400	
	EDS	Az. (cm)			7.40, 7.38 <sup>†</sup>	
Ele. (cm)				7.40, 7.38 <sup>†</sup>		
TIS/TIB/TIC range			0.0-1.0*			

\* Both MI and TI values are below 1.0.

† Each scan point along the scan line consists of two transmit pulses. The first pulse is 1 cycle at 2.95 MHz and the second pulse is 5 cycles at 1.74 MHz. Data for each pulse is provided and separated by a comma.



Table 26. Accuracy Specifications

SPECIFICATION	DESCRIPTION
Bladder volume accuracy	± (15% + 15 ml) on a Verathon® tissue-equivalent phantom
Bladder volume range	0–999 ml in adult modes, 0–200ml in small child mode
Aortic diameter accuracy	± (15% + 0.5 cm) on a Verathon tissue-equivalent phantom
Aortic diameter range	3–12.4 cm

The accuracy specifications assume the instrument is being used according to the instructions provided by Verathon while scanning a tissue-equivalent phantom.

Table 27. Operating & Storage Conditions

SPECIFICATION	DESCRIPTION
<b>Operating Conditions</b>	
Use	Indoor
Ambient temperature range	10–40°C (50–104°F)
Atmospheric pressure range	700–1060 hPa
Relative humidity	30–75% non-condensing
Water resistance	Rated at IPX1 (indicates DRIP-PROOF, a higher than ORDINARY level of protection from drips, leaks, and spills)
<b>Storage Conditions</b>	
Storage	Indoor
Ambient temperature range	-20–60°C (-4–140°F)
Atmospheric pressure range	500–1060 hPa
Relative humidity	20–95% non-condensing

## BATTERY SPECIFICATIONS

The BladderScan BVI 9600 is provided with two lithium-ion batteries. A battery icon on the instrument display is always present indicating how much power remains and when the battery needs to be changed. The user can change the battery whenever necessary.

Removing a discharged battery and replacing with a charged battery should not erase any saved exams or user settings. In the event any user settings change, reset them by following the instructions in the [Setting Up](#) section of this manual.

Use only the battery charger provided with the BVI 9600. Any other battery charger may damage the battery.

Table 28. *Battery Specifications*

CONDITION	DESCRIPTION
Battery type	Lithium-ion
Battery life	A fully charged battery can provide approximately 30 exams within a 24-hour period.
Charging time	Charging time offline will take no more than six hours from an empty battery to a full charge.
Rated capacity	4800–5200 mAh
Normal voltage	11.1 V
Max charging voltage	12.6 V
Max weight	350 g (0.77 lb)
Width	79 mm (3.11 in)
Length	118 mm (4.65 in)
Thickness	23 mm (0.91 in)

## BATTERY CHARGER/WIRELESS HUB SPECIFICATIONS

The battery charger/wireless hub is powered from a standard wall outlet (adaptable to international power standards). The battery charger/wireless hub can charge two batteries simultaneously.

Table 29. Battery Charger/Wireless Hub Specifications

SPECIFICATION	DESCRIPTION
<b>Operating Conditions</b>	
Use	Indoor
Ambient temperature range	5–40°C (41–104°F)
Atmospheric pressure range	700–1060 hPa
Relative humidity	30–75% non-condensing
Water resistance	Rated at IPX0 (ordinary equipment without protection against ingress of water)
Computer connection	USB 2.0
Charger	Powered by a desktop DC power supply.
Input voltage	100–240 VAC RMS
Input frequency	50–60 Hz
Input current	1 A max
Input connection	2 wire IEC 60320 C7
Output	9 V at 1 A
Insulation	Class II with double insulation
Fuses	250 VAC, 2 A, quick acting
Testing	CSA 60950-1-03/UL 60950-1
<b>Storage Conditions</b>	
Storage	Indoor
Ambient temperature range	-20–60°C (-4–140°F)
Atmospheric pressure range	500–1060 hPa
Relative humidity	20–95% non-condensing

## BLUETOOTH WIRELESS TECHNOLOGY

The Bluetooth® technology used in the BladderScan BVI 9600 is compliant with:

- Bluetooth Specification as defined and approved by The Bluetooth Special Interests Group.
- Logo certification with Bluetooth wireless technology as defined by The Bluetooth Special Interest Group.

## ELECTROMAGNETIC COMPATIBILITY

The BladderScan BVI 9600 system is designed to be in compliance with IEC 60601-1-2:2007, which contains electromagnetic compatibility (EMC) requirements for medical electrical equipment. The limits for emissions and immunity specified in this standard are designed to provide reasonable protection against harmful interference in a typical medical installation.

The BladderScan BVI 9600 system complies with the applicable essential performance requirements specified in IEC 60601-1 and IEC 60601-2-37. Results of immunity testing show that the essential performance of the system is not affected under the test conditions described in the following tables. For more information about the essential performance of the BladderScan BVI 9600 system, see [Essential Performance](#) on page 3.

## ELECTROMAGNETIC EMISSIONS

Table 30. *Guidance and Manufacturer’s Declaration—Electromagnetic Emissions*

The BladderScan BVI 9600 system is intended for use in the electromagnetic environment specified below. The customer or the user of the BladderScan BVI 9600 system should assure that it is used in such an environment.

EMISSIONS TEST	COMPLIANCE	ELECTROMAGNETIC ENVIRONMENT – GUIDANCE
RF emissions CISPR 11	Group 1	The BladderScan BVI 9600 system uses RF energy only for its internal function. Therefore, its RF emissions are very low and are not likely to cause any interference in nearby electronic equipment.
RF emissions CISPR 11	Class A	The BladderScan BVI 9600 system is suitable for use in all establishments other than domestic and those directly connected to the public low-voltage power supply network that supplies buildings used for domestic purposes.
Harmonic emissions IEC 61000-3-2	Class A	
Voltage fluctuations/ flicker emissions IEC 61000-3-3	Complies	

## ELECTROMAGNETIC IMMUNITY

Table 31. Guidance and Manufacturer's Declaration—Electromagnetic Immunity

The BladderScan BVI 9600 system is intended for use in the electromagnetic environment specified below. The customer or the user of the BladderScan BVI 9600 system should assure that it is used in such an environment.

IMMUNITY TESTS	IEC 60601 TEST LEVEL	COMPLIANCE LEVEL	ELECTROMAGNETIC ENVIRONMENT – GUIDANCE
Electrostatic discharge (ESD) IEC 61000-4-2	± 6 kV contact ± 8 kV air	In compliance	Floors should be wood, concrete, or ceramic tile. If floors are covered with synthetic material, the relative humidity should be at least 30%.
Electrical fast transient/burst IEC 61000-4-4	± 2 kV for power supply lines ± 1 kV for input/output lines	In compliance	Mains power quality should be that of a typical commercial or hospital environment.
Surge IEC 61000-4-5	± 1 kV line(s) to line(s) ± 2 kV line(s) to earth	In compliance	Mains power quality should be that of a typical commercial or hospital environment.
Voltage dips, short interruptions and voltage variations on power supply input lines IEC 61000-4-11	<5% $U_T$ (>95% dip in $U_T$ ) for 0.5 cycle 40% $U_T$ (60% dip in $U_T$ ) for 5 cycles 70% $U_T$ (30% dip in $U_T$ ) for 25 cycles <5% $U_T$ (>95% dip in $U_T$ ) for 5 s	In compliance	Mains power quality should be that of a typical commercial or hospital environment. If the user of the BladderScan BVI 9600 system requires continued operation during power mains interruptions, it is recommended that the BladderScan BVI 9600 system be powered from an uninterruptible power supply or a battery.
Power frequency (50/60 Hz) magnetic field IEC 61000-4-8	3 A/m	In compliance	Power frequency magnetic fields should be at levels characteristic of a typical location in a typical commercial or hospital environment.
Conducted RF IEC 61000-4-6	3 Vrms 150 kHz to 80 MHz	3 V	Portable and mobile RF communications equipment should be used no closer to any part of the BladderScan BVI 9600 system, including cables, than the recommended separation distance calculated from the equation applicable to the frequency of the transmitter.  <b>Recommended separation distance d (m)</b> $d=1.2 \sqrt{P}$

Table 31. Guidance and Manufacturer’s Declaration—Electromagnetic Immunity

The BladderScan BVI 9600 system is intended for use in the electromagnetic environment specified below. The customer or the user of the BladderScan BVI 9600 system should assure that it is used in such an environment.

IMMUNITY TESTS	IEC 60601 TEST LEVEL	COMPLIANCE LEVEL	ELECTROMAGNETIC ENVIRONMENT – GUIDANCE
Radiated RF IEC 61000-4-3	3 V/m 80 MHz to 2.5 GHz	3 V/m	$d=1.2 \sqrt{P}$ 80 MHz to 800 MHz $d=2.3 \sqrt{P}$ 800 MHz to 2.5 GHz where $P$ is the maximum output power rating of the transmitter in watts (W) according to the transmitter manufacturer and $d$ is the recommended separation distance in meters (m). Field strengths from fixed RF transmitters, as determined by an electromagnetic site survey, <sup>a</sup> should be less than the compliance level in each frequency range. <sup>b</sup> Interference may occur in the vicinity of equipment marked with the following symbol: 

Note:  $U_T$  is the AC mains voltage prior to application of the test level.

At 80 MHz and 800 MHz, the higher frequency range applies.

These guidelines may not apply in all situations. Electromagnetic propagation is affected by absorption and reflection from structures, objects and people.

- a. Field strengths from fixed transmitters, such as base stations for radio (cellular/cordless) telephones and land mobile radios, amateur radio, AM and FM radio broadcast and TV broadcast cannot be predicted theoretically with accuracy. To assess the electromagnetic environment due to fixed RF transmitters, an electromagnetic site survey should be considered. If the measured field strength in the location in which the BladderScan BVI 9600 system is used exceeds the applicable RF compliance level above, the BladderScan BVI 9600 system should be observed to verify normal operation. If abnormal performance is observed, additional measures may be necessary, such as re-orienting or relocating the BladderScan BVI 9600 system.
- b. Over the frequency range 150 kHz to 80 MHz, field strengths should be less than 3 V/m.

## RECOMMENDED SEPARATION DISTANCES

Table 32. Recommended Separation Distances between Portable and Mobile RF Communications Equipment and the BladderScan BVI 9600 System

The BladderScan BVI 9600 system is intended for use in an electromagnetic environment in which radiated RF disturbances are controlled. The customer or the user of the BladderScan BVI 9600 system can help prevent electromagnetic interference by maintaining a minimum distance between portable and mobile RF communications equipment (transmitters) and the BladderScan BVI 9600 system as recommended below, according to the maximum output power of the communications equipment.

RATED MAXIMUM OUTPUT POWER OF TRANSMITTER (W)	SEPARATION DISTANCE ACCORDING TO FREQUENCY OF TRANSMITTER (m)		
	150 kHz to 80 MHz $d=1.2 \sqrt{P}$	80 MHz to 800 MHz $d=1.2 \sqrt{P}$	800 MHz to 2.5 GHz $d=2.3 \sqrt{P}$
0.01	0.12	0.12	0.23
0.1	0.38	0.38	0.73
1	1.2	1.2	2.3
10	3.8	3.8	7.3
100	12	12	23

For transmitters rated at a maximum output power not listed above, the recommended separation distance  $d$  in meters (m) can be estimated using the equation applicable to the frequency of the transmitter, where  $P$  is the maximum output power rating of the transmitter in watts (W) according to the transmitter manufacturer.

Note: At 80 MHz and 800 MHz, the separation distance for the higher frequency range applies.

These guidelines may not apply in all situations. Electromagnetic propagation is affected by absorption and reflection from structures, objects and people.















## ACCESSORY CONFORMANCE TO STANDARDS

To maintain electromagnetic interference (EMI) within certified limits, the system must be used with the cables, components, and accessories specified or supplied by Verathon®. For additional information, see the [System Components & Accessories](#) and [Component Specifications](#) sections. The use of accessories or cables other than those specified or supplied may result in increased emissions or decreased immunity of the system.





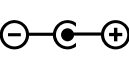









Table 33. EMC Standards for Accessories



ACCESSORY	MAX LENGTH
AC power cord	2 m (6.6 ft)
USB cable	1.9 m (6.2 ft)
Desktop power supply	—

# SYMBOL DIRECTORY

SYMBOL	MEANING
<b>Warnings &amp; Cautions</b>	
	Warning or Caution—Consult accompanying documents. Read instructions before connecting or operating.
	Risk of electric shock
	Flammable material
	Non-ionizing, electromagnetic radiation
<b>Product Use &amp; Specifications</b>	
	Refer to the operations & maintenance manual
	Manufacturer
	Date of manufacture
	Use-by date
	Catalog (part) number
	Serial number
	Batch code
	Temperature limitation
	Statement of prescription
<b>Shipping &amp; Disposal</b>	
	Lithium-ion battery in package
	Fragile item, handle carefully



SYMBOL	MEANING
<b>Electrical &amp; Power</b>	
	Class II equipment
	Type BF applied part
	Energy Efficiency Level V
	Battery operated
	Connector polarity mark—positive
	Connect to power supply
<b>LPS</b>	Limited power source
	USB
<b>Standards &amp; Certifications</b>	
	CE—Marked in accordance with the Medical Device Directive (MDD)
	CSA—Canadian Standards Association mark of certification to applicable standards for electromedical equipment
	FCC—Tested to Federal Communications Commission requirements
	EC REP—Authorized Representative in the European Community
	WEEE—Subject to waste electrical and electronic equipment regulations
	TUV—Safety approval mark for components or subassemblies
	GS—German safety approval showing conformity with the German Equipment Safety Law

SYMBOL	MEANING
	UL—Underwriters Laboratories Certification mark for electrical shock, fire, and mechanical hazards only
	UL—Underwriters Laboratories Recognized Component certification mark

# GLOSSARY

TERM	DEFINITION
A	Ampere
C	Celsius
cm	Centimeter
CSA	Canadian Standards Association
DC	Direct current
EMC	Electromagnetic compatibility
EMI	Electromagnetic interference
Essential performance	The system performance necessary to achieve freedom from unacceptable risk
ESD	Electrostatic discharge
F	Fahrenheit
g	Gram
GHz	Gigahertz
HIPAA	Health Insurance Portability and Accountability Act
hPa	Hectopascal
Hz	Hertz
IEC	International Electrotechnical Commission
Image cone	Cone-shaped area in which the probe transmits ultrasound waves
in	Inch
ISM	Industrial, scientific, and medical
ISPPA	Spatial-peak, pulse-average intensity
ISPTA	Spatial-peak, temporal-average intensity
LAN	Local area network
LCD	Liquid crystal display
m	Meter
mAh	Milliamperere-hour
MDD	Medical Device Directive
MHz	Megahertz
MI	Mechanical index
mm	Millimeter
RF	Radio frequency
RMS	Root mean square
UL	Underwriters Laboratories
V	Volt
VAC	Volt alternating current
W	Watt
WEEE	Waste electrical and electronic equipment





